



Sample image









## Datasheet

**Article number:** 70025927

**Designation:** CG4.A004.E

**Description:** Switch

IEC 60947-3 EN 60947-3, VDE 0660 Teil 107						
<b>Rated insulation voltage Ui</b>						
			Voltage (V) AC / DC			
			440 AC / DC			
<b>Rated uninterrupted current Iu/Ith</b>						
Current (A)	Ambient temperature (°C)		Peak temperature (°C)		additional requirements	
10	55		60		Ambient temperature +55°C during 24 hours with peaks up to +60°C	
<b>Rated operational current Ie</b>						
Utilization category			Voltage (V)		Current (A)	
AC-15			220 - 240		2,50	
AC-15			380 - 440		1,50	
<b>Rated operational power</b>						
Utilization category	Voltage (V)	No. of phases		No. of poles		Power (kW)
AC-3	220 - 240	3		3		1,50
AC-3	380 - 440	3		3		2,20
AC-3	220 - 240	1		2		0,55
AC-3	380 - 440	1		2		0,75
AC-23A	220 - 240	3		3		1,80
AC-23A	380 - 440	3		3		3
AC-23A	220 - 240	1		2		0,75
AC-23A	380 - 440	1		2		1,10
<b>Max. Fuse rating IEC</b>						
Fuse characteristic				No. of Fuses		Current (A)
gG				1		10
<b>UL60947-4-1, UL508</b>						
<b>Nominal Voltage</b>						
			Voltage (V) AC / DC			
			300 AC			
<b>Rated insulation voltage Ui</b>						
			Voltage (V) AC / DC			
			300 AC			
<b>Rated thermal current</b>						
		Current (A)	Ambient temperature (°C)		Additional Text	
		10	0 - 40		-	
<b>Horsepower rating</b>						
<i>Across-the-Line Motor Starting</i>		Voltage (V)	No. of phases	No. of poles	Power (HP)	Ambient temperature [°C]
DOL		110 - 120	1	2	0,33	40
DOL		220 - 240	1	2	0,75	40
DOL		277 - 277	1	2	0,75	40
DOL		110 - 120	3	3	0,75	40
DOL		220 - 240	3	3	1	40
<b>Pilot duty rating code</b>						
Duty Code						
A300						
<b>Temp. rating of wire</b>						
			Temperature rating (°C)	Current (A)		Text
			60 - 75			-- Use copper wire only
<b>General Use</b>						
AC / DC	Voltage (V)	Current (A)	No. of phases	No. of poles		No. of contacts in series
AC	120	10	1	1		1
AC	300	10	1	2		1
AC	300	10	3	3		1
<b>CSA</b>						
<b>Nominal Voltage</b>						
			Voltage (V) AC / DC			
			300 AC			
<b>Rated insulation voltage Ui</b>						
			Voltage (V) AC / DC			
			300 AC			

Rated thermal current						
		Current (A)	Ambient temperature (°C)		Additional Text	
		10	0 - 40		-	
Horsepower rating						
Across-the-Line Motor Starting						
	Voltage (V)	No. of phases	No. of poles	Power (HP)	Ambient temperature [°C]	
DOL	110 - 120	1	2	0,33	40	
DOL	220 - 240	1	2	0,75	40	
DOL	277 - 277	1	2	0,75	40	
DOL	110 - 120	3	3	0,75	40	
DOL	220 - 240	3	3	1	40	
Pilot duty rating code						
Duty Code						
A300						
Temp. rating of wire						
		Temperature rating (°C)	Current (A)		Text	
		75	--		--	
General Use						
AC / DC	Voltage (V)	Current (A)	No. of phases	No. of poles	No. of contacts in series	
AC	120	10	1	1	1	
AC	300	10	1	2	1	
AC	300	10	3	3	1	
GENERAL TECHNICAL INFORMATION						
Size of conductor						
composition of conductor	Min. / Max. value	No. of conductor per terminal	Cross section (mm <sup>2</sup> ) or (AWG/kcmil)		Material of the wire	
Solid wire	Min.	1	0.5mm <sup>2</sup>		Copper	
Solid wire	Min.	2	0.5mm <sup>2</sup>		Copper	
Flexible wire	Min.	1	0.75mm <sup>2</sup>		Copper	
Flexible wire	Min.	2	0.75mm <sup>2</sup>		Copper	
Flexible wire	Max.	2	AWG 16		Copper	
Flexible wire	Max.	2	1.5mm <sup>2</sup>		Copper	
Single-core or stranded wire	Max.	2	AWG 14		Copper	
Single-core or stranded wire	Max.	2	1.5mm <sup>2</sup>		Copper	
Flexible wire with ferrule according to DIN 46228	Min.	1	0.5mm <sup>2</sup>		Copper	
Flexible wire with ferrule according to DIN 46228	Max.	2	1mm <sup>2</sup>		Copper	
Flexible wire with ferrule according to DIN 46228	Min.	2	0.5mm <sup>2</sup>		Copper	
Stripping length						
Length (mm) --						
						
Recommended screw driver						
Type of screw driver		Value				
Cross Screwdriver		PH1				
Slot screwdriver according to DIN 5264		0,6x3,5				
Tightening torque of screws						
		tightening torque (Nm)		tightening torque (lb-in)		
		0,40		3,50		
Approbations						
Specification					Marking	
EAC						
CE marking						
UK Directives						
CSA C.22.2 No.14						
GB/T14048.3						
General Information						
Text						
<ul style="list-style-type: none"> <li>- Use only copper wires with or without tinned/silver-plated individual wires. Soldering the end of the wire before wiring is not allowed.</li> <li>- Terminals with factory fitted jumper links are tightened during production for loss prevention. When opening the terminal clamps, make sure that no factory fitted links get lost and that all wire connections are properly seated.</li> <li>- After wiring, ALL terminal screws must be tightened to the specified torque values.</li> <li>- The protection class of the selected mounting type may vary if optional extras are used.</li> <li>- Do not lubricate or treat contacts.</li> <li>- Switches may only be mounted, connected and set into operation by qualified persons according to the accepted rules of technology.</li> <li>- After installation of the switches the spacings between the terminals must be sufficient to fulfill the requirement of the applicable standards.</li> </ul>						
Waste Electrical & Electronic Equipment (WEEE)						
Picture name	Description					
	Do not throw in the trash as care must be taken to ensure environmentally sound disposal and recycling. Please either use an environmentally friendly waste disposal company; return to the supplier for disposal; or return direct to the manufacturer, Kraus & Naimer. You can find local Kraus & Naimer offices at <a href="http://www.krausnaimer.com">www.krausnaimer.com</a>					
Proposition 65						
Picture name	Description					
	WARNING: This product can expose you to chemicals including nickel and lead, which is known to the State of California to cause cancer. For more information go to <a href="http://www.P65Warnings.ca.gov">www.P65Warnings.ca.gov</a> .					

Classification Contact: Rigid contact bridge

Classification Contact Mat: Silver

Classification Terminal: Screw terminal

### Mounting-E

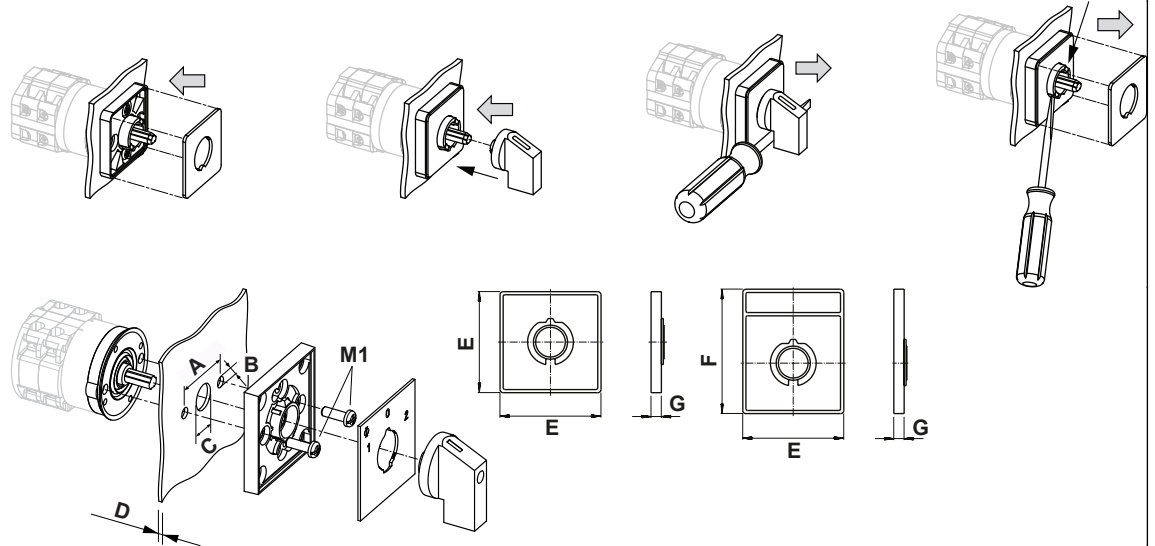

IP - Code front side		IP40
Stages		1,00 - 8,00
A	H	20,00 mm
B	Ø	3,20 mm
C	Ø	8,00 - 11,00 mm
D	H	<= 4,00 mm
E	H	30,00 mm
F	H	39,00 mm
G	H	5,50 mm
M1	M̄	0,40 Nm

## Wiring diagram

CG4.A004.E

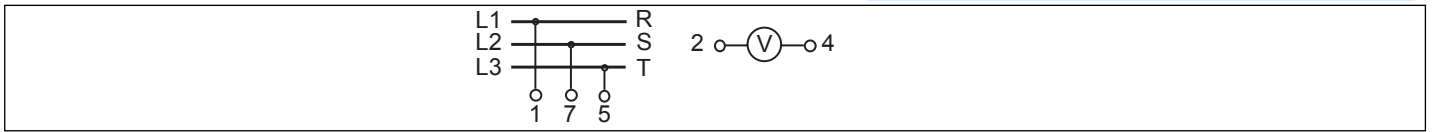

# Switch program

CG4.A004.E

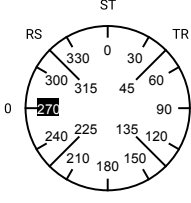
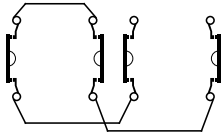
 Kraus & Naimer		CG4		A004		E		Page 1 of 1					
		1	3	5	7	9	11	13	15	17	19	21	23
<b>Face Plate</b> 													
Switching Angle <input type="text" value="45"/> Total switching Angle <input type="text" value="135"/>		2	4	6	8	10	12	14	16	18	20	22	24
0	270												
	285												
	300												
RS	315	■			■								
	330												
	345												
ST	0			■	■								
	15												
	30												
TR	45		■	■									
	60												
	75												
	90												
	105												
	120												
	135												
	150												
	165												
	180												
	195												
	210												
	225												
	240												
	255												

Version: 43

**Face plate**

S00.F775/A1B.PE

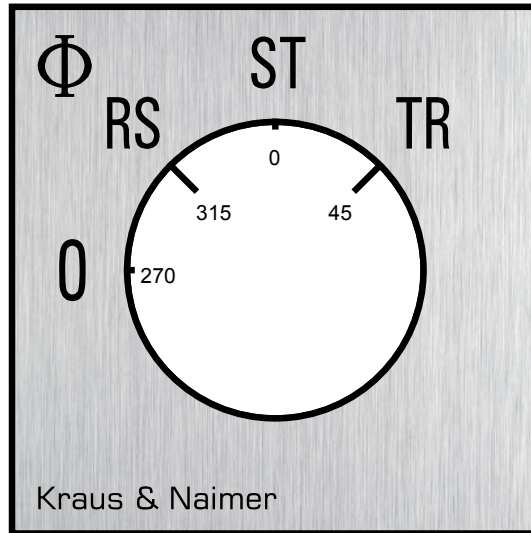

## HANDLES

**Designation:** S00.G251  
**Handle colour:** "1" black

