

Sample image

Datasheet

Article number: 70009703

Designation: CG8.A048.E

Description: Switch

IEC 60947-3 EN 60947-3, VDE 0660 Teil 107						
Rated insulation voltage Ui						
			Voltage (V) AC / DC			
			690 AC / DC			
Rated uninterrupted current Iu/Ith						
Current (A)	Ambient temperature (°C)		Peak temperature (°C)		additional requirements	
20	55		60		Ambient temperature +55°C during 24 hours with peaks up to +60°C	
Rated operational current Ie						
Utilization category			Voltage (V)		Current (A)	
AC-15			220 - 240		6	
AC-15			380 - 440		4	
Rated operational power						
Utilization category	Voltage (V)		No. of phases		No. of poles	
AC-3	220 - 240		3		3	
AC-3	380 - 440		3		3	
AC-3	660 - 690		3		3	
AC-3	220 - 240		1		2	
AC-3	380 - 440		1		2	
AC-23A	220 - 240		3		3	
AC-23A	380 - 440		3		3	
AC-23A	660 - 690		3		3	
AC-23A	220 - 240		1		2	
AC-23A	380 - 440		1		2	
Max. Fuse rating IEC						
Fuse characteristic			No. of Fuses		Current (A)	
gG			1		25	
UL60947-4-1 , UL508						
Nominal Voltage						
			Voltage (V) AC / DC			
			300 AC			
Rated insulation voltage Ui						
			Voltage (V) AC / DC			
			300 AC			
Rated thermal current						
		Current (A)	Ambient temperature (°C)		Additional Text	
		16	0 - 40		-	
Horsepower rating						
<i>Across-the-Line Motor Starting</i>			Voltage (V)	No. of phases	No. of poles	Power (HP)
Reversing			110 - 120	1	2	0,17
Reversing			220 - 240	1	2	0,50
Reversing			277 - 277	1	2	0,50
Reversing			110 - 120	3	3	0,50
Reversing			220 - 240	3	3	1
DOL			110 - 120	1	2	0,50
DOL			220 - 240	1	2	1
DOL			277 - 277	1	2	1
DOL			110 - 120	3	3	1,50
DOL			220 - 240	3	3	1
Pilot duty rating code						
Duty Code						
A300						
SCCR / Max. fuse rating						
Conditions of acceptability						
These devices are suitable for use on circuits capable of delivering not more than 5kA rms symmetrical amperes, 600V ac max. when protected by Class RK1 fuses.						
Temp. rating of wire						
			Temperature rating (°C)	Current (A) Text		
			60 - 75	- Use copper wire only		
General Use						
AC / DC	Voltage (V)	Current (A)	No. of phases	No. of poles	No. of contacts in series	
AC	150	16	1	2	1	

General Use								
AC / DC	Voltage (V)	Current (A)	No. of phases	No. of poles	No. of contacts in series			
AC	150	16	3	3	1			
AC	300	10	1	2	1			
AC	300	10	3	3	1			
CSA								
Nominal Voltage								
				Voltage (V) AC / DC				
				300 AC				
Rated insulation voltage Ui								
				Voltage (V) AC / DC				
				300 AC				
Rated thermal current								
		Current (A)	Ambient temperature (°C)		Additional Text			
		16	0 - 40		--			
Horsepower rating								
Across-the-Line Motor Starting				Voltage (V)	No. of phases	No. of poles	Power (HP)	Ambient temperature [°C]
DOL				110 - 120	1	2	0,50	40
DOL				220 - 240	1	2	1	40
DOL				277 - 277	1	2	2	40
DOL				110 - 120	3	3	1,50	40
DOL				220 - 240	3	3	3	40
Pilot duty rating code								
Duty Code								
A300								
SCCR / Max. fuse rating								
Conditions of acceptability								
These devices are suitable for use on circuits capable of delivering not more than 5kA rms symmetrical amperes, 600V ac max. when protected by Class RK1 fuses.								
Temp. rating of wire								
			Temperature rating (°C)	Current (A) Text				
			75	-- --				
General Use								
AC / DC	Voltage (V)	Current (A)	No. of phases	No. of poles	No. of contacts in series			
AC	150	16	1	1	1			
AC	300	10	1	1	1			
AC	300	10	3	3	1			
GENERAL TECHNICAL INFORMATION								
Size of conductor								
composition of conductor	Min. / Max. value	No. of conductor per terminal		Cross section (mm ²) or (AWG/kcmil)		Material of the wire		
Solid wire	Min.	1		0.5mm ²		Copper		
Solid wire	Min.	2		0.5mm ²		Copper		
Flexible wire	Min.	1		0.75mm ²		Copper		
Flexible wire	Min.	2		0.75mm ²		Copper		
Flexible wire	Max.	2		2.5mm ²		Copper		
Flexible wire	Max.	2		AWG 14		Copper		
Single-core or stranded wire	Max.	2		AWG 12		Copper		
Single-core or stranded wire	Max.	2		2.5mm ²		Copper		
Flexible wire with ferrule according to DIN 46228	Min.	1		0.5mm ²		Copper		
Flexible wire with ferrule according to DIN 46228	Max.	2		2.5mm ²		Copper		
Flexible wire with ferrule according to DIN 46228	Min.	2		0.5mm ²		Copper		
Stripping length								
				Length (mm) --				
								
Recommended screw driver								
Type of screw driver				Value				
Cross Screwdriver				PH1				
Slot screwdriver according to DIN 5264				0,8x4				
Tightening torque of screws								
			tightening torque (Nm)		tightening torque (lb-in)			
			0,60		5			
Approbations								
Specification						Marking		
EAC								
CE marking								
UK Directives								
CSA C.22.2 No.14								
GB/T14048.3								

General Information

Text

- Use solo alambres de cobre con o sin alambres individuales chapados en estaño/plata. No se permite el estañado posterior de los extremos del conductor.
- Terminals with factory fitted jumper links are tightened during production for loss prevention. When opening the terminal clamps, make sure that no factory fitted links get lost and that all wire connections are properly seated.
- After wiring, ALL terminal screws must be tightened to the specified torque values.
- La clase de protección del tipo de montaje seleccionado puede variar si se utilizan extras opcionales.
- Do not lubricate or treat contacts.
- Switches may only be mounted, connected and set into operation by qualified persons according to the accepted rules of technology.
- After installation of the switches the spacings between the terminals must be sufficient to fulfill the requirement of the applicable standards.

Waste Electrical & Electronic Equipment (WEEE)

Picture name Description



Do not throw in the trash as care must be taken to ensure environmentally sound disposal and recycling. Please either use an environmentally friendly waste disposal company; return to the supplier for disposal; or return direct to the manufacturer, Kraus & Naimer. You can find local Kraus & Naimer offices at www.krausnaimer.com

Proposition 65

Picture name Description



WARNING: This product can expose you to chemicals including nickel and lead, which is known to the State of California to cause cancer. For more information go to www.P65Warnings.ca.gov.

Classification Contact: Rigid contact bridge

Classification Contact Mat: Silver

Classification Terminal: Screw terminal

Mounting-E

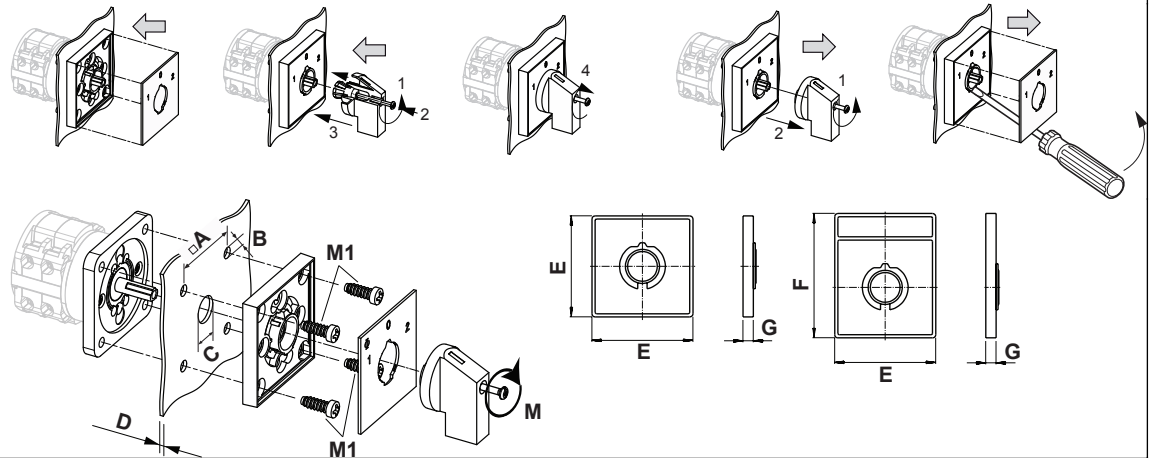

IP - Code front side		IP40
Stages		1,00 - 12,00
A	□	36,00 mm
B	∅	5,00 mm
C	∅	8,00 - 19,00 mm
D	H	<= 4,00 mm
E	H	48,00 mm
F	H	59,00 mm
G	H	6,70 mm
M	⌀	0,50 Nm
M1	⌀	0,90 Nm

Wiring diagram

CG8.A048.E

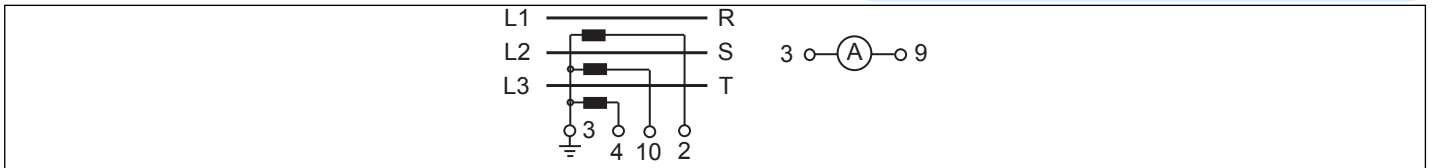

Switch program

CG8.A048.E

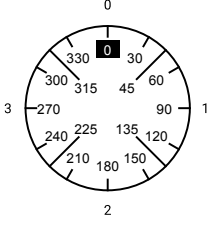
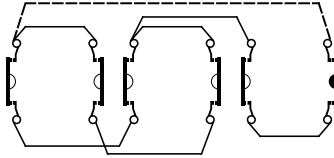
 Kraus & Naimer		CG8		A048		E		Page 1 of 1					
		Face Plate		1	3	5	7	9	11	13	15	17	19
													
Switching Angle <input type="text" value="90"/> Total switching Angle <input type="text" value="360"/>		2	4	6	8	10	12	14	16	18	20	22	24
0	0	█	█				█						
	15												
	30												
	45												
	60	█		█									
	75												
1	90												
	105												
	120	█		█									
	135												
	150							█		█			
	165												
2	180												
	195												
	210												
	225												
	240	█		█									
	255												
3	270												
	285												
	300		█		█								
	315												
	330												
	345												

Version: 44

Face plate

S0.F059/A1B.PEL

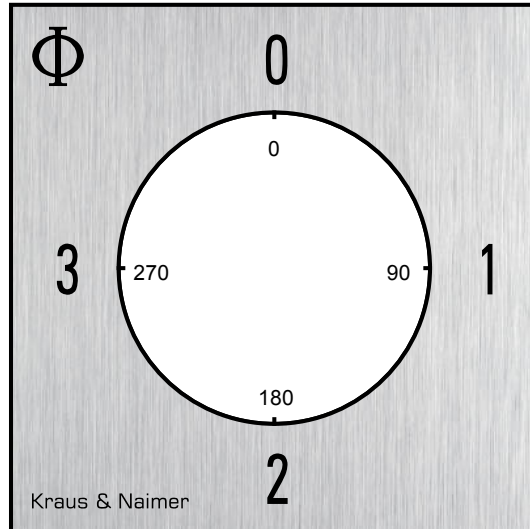

HANDLES

Designation: SOC.G251
Handle colour: "1" black

GENERAL TECHNICAL INFORMATION

Recommended screw driver

Type of screw driver	Value
Cross Screwdriver	PH1
Slot screwdriver according to DIN 5264	0,8x4

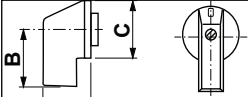

A	22,00 mm	B	23,80 mm	C	27,60 mm
---	----------	---	----------	---	----------