







Sample image

Datasheet

Article number: 70002020
Designation: CA10.A201.EF
Description: Switch

IEC 60947-3 EN 60947-3, VDE 0660 Teil 107						
Rated insulation voltage U_i						
			Voltage (V) AC / DC			
			690 AC / DC			
Rated impulse withstand voltage U_{imp}						
Voltage (kV)	Overvoltage category	Pollution degree	Supply system			Function
4 III		3	Valid for lines with grounded common neutral termination			Switch disconnecter
Rated uninterrupted current I_u/I_{th}						
Current (A)	Ambient temperature (°C)	Peak temperature (°C) additional requirements				
20	55	60 Ambient temperature +55°C during 24 hours with peaks up to +60°C				
Rated operational current I_e						
Utilization category			Voltage (V)		Current (A)	
AC-15			220 - 240		6	
AC-15			380 - 440		4	
Rated operational power						
Utilization category	Voltage (V)	No. of phases	No. of poles	Power (kW)		
AC-3	220 - 240	3	3	3		
AC-3	380 - 440	3	3	5,50		
AC-3	660 - 690	3	3	5,50		
AC-3	220 - 240	1	2	2,20		
AC-3	380 - 440	1	2	3		
AC-23A	220 - 240	3	3	3,70		
AC-23A	380 - 440	3	3	7,50		
AC-23A	660 - 690	3	3	7,50		
AC-23A	220 - 240	1	2	2,50		
AC-23A	380 - 440	1	2	3,70		
Max. Fuse rating IEC						
Fuse characteristic			No. of Fuses		Current (A)	
gG			1		25	
UL60947-4-1 , UL508						
Nominal Voltage						
			Voltage (V) AC / DC			
			300 AC / DC			
Rated insulation voltage U_i						
			Voltage (V) AC / DC			
			300 AC			
Rated thermal current						
		Current (A)	Ambient temperature (°C) Additional Text			
		20	0 - 40 --			
Horsepower rating						
Across-the-Line Motor Starting		Voltage (V)	No. of phases	No. of poles	Power (HP)	Ambient temperature [°C]
Reversing		110 - 120	1	2	0,17	40
Reversing		220 - 240	1	2	0,50	40
Reversing		277 - 277	1	2	0,60	40
Reversing		110 - 120	3	3	0,50	40
Reversing		220 - 240	3	3	1	40
DOL		110 - 120	1	2	0,50	40
DOL		220 - 240	1	2	1	40
DOL		277 - 277	1	2	2	40
DOL		110 - 120	3	3	1,50	40
DOL		220 - 240	3	3	3	40
Pilot duty rating code						
Duty Code						
A300						
SCCR / Max. fuse rating						
Conditions of acceptability						
These devices are suitable for use on circuits capable of delivering not more than 5000 rms symmetrical amperes, 600V ac max. when protected by Class RK1 fuses. Manual Motor Controllers when intended for use as a motor disconnecter are suitable for use on a circuit capable of delivering not more than 5000 rms symmetrical amperes, 600V ac max. when protected by 30A Class J time delay fuses.						
Temp. rating of wire						
		Temperature rating (°C)	Current (A) Text			
		60 - 75	-- Use copper wire only			

Connecting instructions						
Markings						
When intended for use as a motor disconnecter the device shall be provided with a method of being locked in the OFF-position.						
General Use						
AC / DC	Voltage (V)	Current (A)	No. of phases	No. of poles	No. of contacts in series	
AC	300	20	1	2	1	
AC	300	20	3	3	1	
CSA						
Nominal Voltage						
				Voltage (V)	AC / DC	
				300 AC		
Rated insulation voltage Ui						
				Voltage (V)	AC / DC	
				300 AC		
Rated thermal current						
		Current (A)	Ambient temperature (°C)		Additional Text	
		20	0 - 40		-	
Horsepower rating						
<i>Across-the-Line Motor Starting</i>						
	Voltage (V)	No. of phases	No. of poles	Power (HP)	Ambient temperature [°C]	
DOL	110 - 120	1	2	0,50	40	
DOL	220 - 240	1	2	1	40	
DOL	277 - 277	1	2	2	40	
DOL	110 - 120	3	3	1,50	40	
DOL	220 - 240	3	3	3	40	
Pilot duty rating code						
<i>Duty Code</i>						
A300						
Temp. rating of wire						
		Temperature rating (°C)	Current (A)		Text	
		75			- only	
General Use						
AC / DC	Voltage (V)	Current (A)	No. of phases	No. of poles	No. of contacts in series	
AC	300	20	1	1	1	
GENERAL TECHNICAL INFORMATION						
Size of conductor						
<i>composition of conductor</i>	<i>Min. / Max. value</i>	<i>No. of conductor per terminal</i>		<i>Cross section (mm²) or (AWG/kcmil)</i>	<i>Material of the wire</i>	
Solid wire	Min.	1		0.5mm ²	Copper	
Solid wire	Min.	2		0.5mm ²	Copper	
Flexible wire	Min.	1		0.75mm ²	Copper	
Flexible wire	Min.	2		0.75mm ²	Copper	
Flexible wire	Max.	2		2.5mm ²	Copper	
Flexible wire	Max.	2		AWG 14	Copper	
Single-core or stranded wire	Max.	2		AWG 12	Copper	
Single-core or stranded wire	Max.	2		2.5mm ²	Copper	
Flexible wire with ferrule according to DIN 46228	Min.	1		0.5mm ²	Copper	
Flexible wire with ferrule according to DIN 46228	Max.	2		2.5mm ²	Copper	
Flexible wire with ferrule according to DIN 46228	Min.	2		0.5mm ²	Copper	
Stripping length						
				Length (mm)	-	
						
Recommended screw driver						
<i>Type of screw driver</i>				<i>Value</i>		
Cross Screwdriver				PH1		
Slot screwdriver according to DIN 5264				0,8x4		
Tightening torque of screws						
				tightening torque (Nm)	tightening torque (lb-in)	
				0,60	5	
Approbations						
<i>Specification</i>						<i>Marking</i>
CE marking						
UK Directives						
CSA C.22.2 No.14						
General Information						
<i>Text</i>						
- Alleen koperleidingen met of zonder vertinde/verzilverde draden (per draad) gebruiken. Het nadien vertinnen van de uiteinden is niet toegestaan.						
- DC switching capacity applies to ON/OFF switches.						
- Terminals with factory fitted jumper links are tightened during production for loss prevention. When opening the terminal clamps, make sure that no factory fitted links get lost and that all wire connections are properly seated.						
- After wiring, ALL terminal screws must be tightened to the specified torque values.						
- Het gebruik van een extra apparaat kan de beschermingsklasse van de gekozen bouwvorm beïnvloeden.						

General Information

Text

- Do not lubricate or treat contacts.
- Switches may only be mounted, connected and set into operation by qualified persons according to the accepted rules of technology.
- After installation of the switches the spacings between the terminals must be sufficient to fulfill the requirement of the applicable standards.

Waste Electrical & Electronic Equipment (WEEE)

Picture name Description



Do not throw in the trash as care must be taken to ensure environmentally sound disposal and recycling. Please either use an environmentally friendly waste disposal company; return to the supplier for disposal; or return direct to the manufacturer, Kraus & Naimer. You can find local Kraus & Naimer offices at www.krausnaimer.com

Proposition 65

Picture name Description



WARNING: This product can expose you to chemicals including nickel and lead, which is known to the State of California to cause cancer. For more information go to www.P65Warnings.ca.gov.

Classification Contact: Rigid contact bridge

Classification Contact Mat: Silver

Classification Terminal: Screw terminal

Mounting-EF

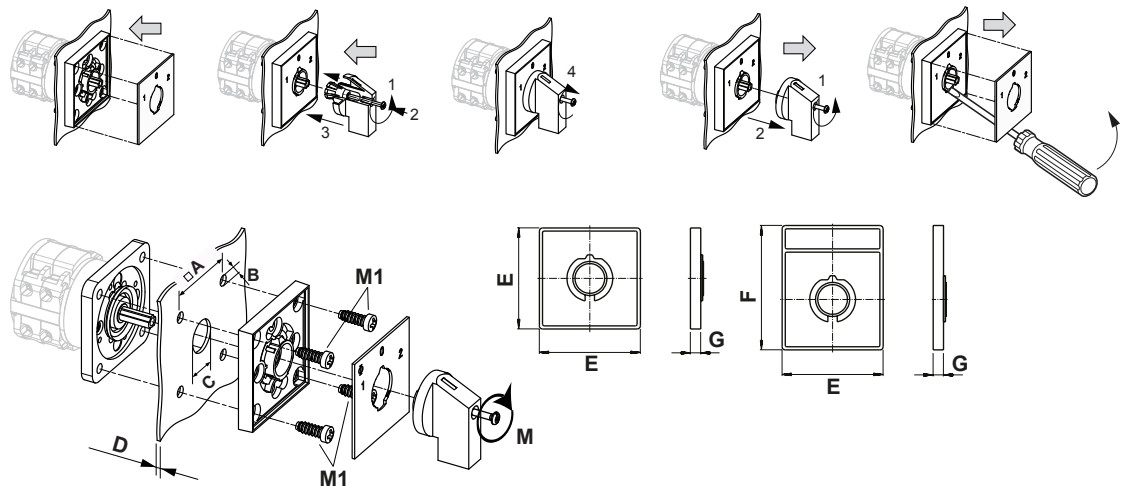

IP - Code front side	IP66, IP67, IP69k
Stages	1,00 - 12,00
A	□ 36,00 mm
B	∅ 5,00 mm
C	∅ 15,00 - 19,00 mm
D	H ≤ 4,00 mm
E	H 48,00 mm
F	H 59,00 mm
G	H 6,70 mm
M	↺ 0,50 Nm
M1	↺ 0,90 Nm

Wiring diagram

CA10.A201.EF

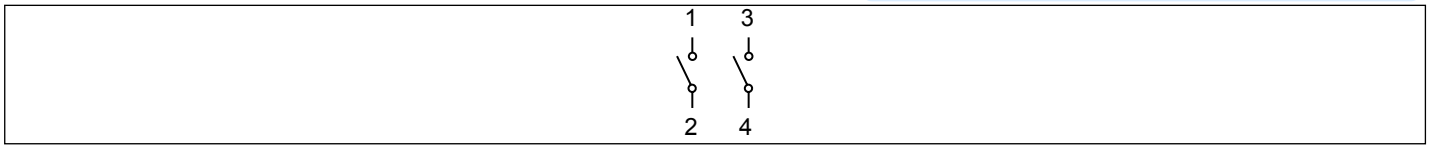

Switch program

CA10.A201.EF

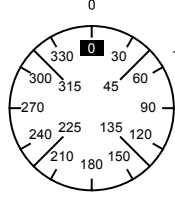
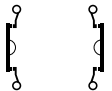
 Kraus & Naimer		CA10				A201				Page 1 of 1			
		Face Plate											
													
		1	3	5	7	9	11	13	15	17	19	21	23
Switching Angle <input type="text" value="60"/> Total switching Angle <input type="text" value="60"/>		2	4	6	8	10	12	14	16	18	20	22	24
0													
15													
30													
45													
60		■	■										
75													
90													
105													
120													
135													
150													
165													
180													
195													
210													
225													
240													
255													
270													
285													
300													
315													
330													
345													
		Jumpers											
		1 ●	●3	4 ●	●2								
		5 ○	○7	8 ○	○6								
		9 ○	○11	12 ○	○10								
		13 ○	○15	16 ○	○14								
		17 ○	○19	20 ○	○18								
		21 ○	○23	24 ○	○22								
		25 ○	○27	28 ○	○26								
		29 ○	○31	32 ○	○30								
		33 ○	○35	36 ○	○34								
		37 ○	○39	40 ○	○38								
		41 ○	○43	44 ○	○42								
		45 ○	○47	48 ○	○46								

Version: 123

Face plate

S0.F070/A1B.PEL

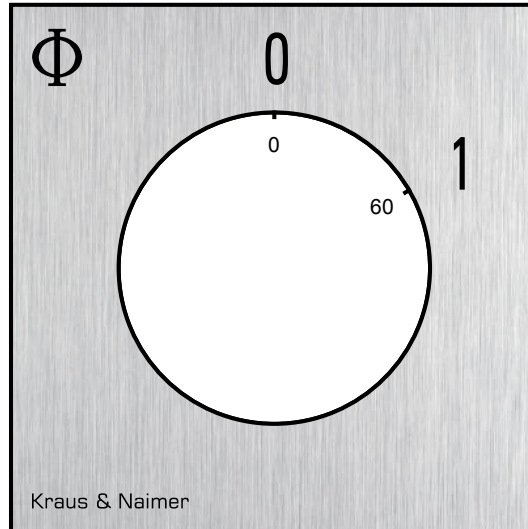

HANDLES

Designation: SOC.G251
Handle colour: "1" black

GENERAL TECHNICAL INFORMATION

Recommended screw driver

Type of screw driver	Value
Cross Screwdriver	PH1
Slot screwdriver according to DIN 5264	0,8x4

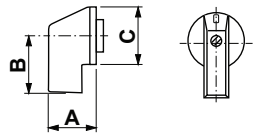

A	22,00 mm	B	23,80 mm	C	27,60 mm
---	----------	---	----------	---	----------