





Sample image

## Datasheet

**Article number:** 70005601  
**Designation:** CA20.A293.EF  
**Description:** Switch

<b>IEC 60947-3 EN 60947-3, VDE 0660 Teil 107</b>						
<b>Rated insulation voltage Ui</b>						
			Voltage (V) AC / DC			
			690 AC / DC			
<b>Rated uninterrupted current Iu/Ith</b>						
Current (A)	Ambient temperature (°C)		Peak temperature (°C)		additional requirements	
25	55		60		Ambient temperature +55°C during 24 hours with peaks up to +60°C	
<b>Rated operational current Ie</b>						
Utilization category			Voltage (V)		Current (A)	
AC-15			220 - 240		8	
AC-15			380 - 440		5	
<b>Rated operational power</b>						
Utilization category	Voltage (V)		No. of phases		No. of poles	
AC-3	220 - 240		3		3	
AC-3	380 - 440		3		3	
AC-3	660 - 690		3		3	
AC-3	220 - 240		1		2	
AC-3	380 - 440		1		2	
AC-23A	220 - 240		3		3	
AC-23A	380 - 440		3		3	
AC-23A	660 - 690		3		3	
AC-23A	220 - 240		1		2	
AC-23A	380 - 440		1		2	
<b>Max. Fuse rating IEC</b>						
Fuse characteristic			No. of Fuses		Current (A)	
gG			1		35	
<b>UL60947-4-1 , UL508</b>						
<b>Nominal Voltage</b>						
			Voltage (V) AC / DC			
			600 AC			
<b>Rated insulation voltage Ui</b>						
			Voltage (V) AC / DC			
			600 AC			
<b>Rated thermal current</b>						
		Current (A)	Ambient temperature (°C)		Additional Text	
		30	0 - 40		-	
<b>Horsepower rating</b>						
Across-the-Line Motor Starting			Voltage (V)	No. of phases	No. of poles	Power (HP)
Reversing			110 - 120	1	2	0,33
Reversing			220 - 240	1	2	0,75
Reversing			277 - 277	1	2	1
Reversing			415 - 415	1	2	1,50
Reversing			440 - 480	1	2	2
Reversing			550 - 600	1	2	2
Reversing			110 - 120	3	3	1
Reversing			220 - 240	3	3	2
Reversing			415 - 415	3	3	3
Reversing			440 - 480	3	3	5
Reversing			550 - 600	3	3	5
DOL			110 - 120	1	2	1,50
DOL			220 - 240	1	2	3
DOL			277 - 277	1	2	3
DOL			415 - 415	1	2	3
DOL			440 - 480	1	2	5
DOL			550 - 600	1	2	5
DOL			110 - 120	3	3	3
DOL			220 - 240	3	3	7,50
DOL			415 - 415	3	3	7,50
DOL			440 - 480	3	3	10
DOL			550 - 600	3	3	10

<b>Pilot duty rating code</b>						
Duty Code						
A600						
<b>SCCR / Max. fuse rating</b>						
Conditions of acceptability						
These devices are suitable for use on circuits capable of delivering not more than 5000 rms symmetrical amperes, 600V ac max. when protected by Class RK1 fuses. Manual Motor Controllers when intended for use as a motor disconnect are suitable for use on a circuit capable of delivering not more than 5000 rms symmetrical amperes, 600V ac max. when protected by 30A Class J time delay fuses.						
<b>Temp. rating of wire</b>						
Temperature rating (°C)			Current (A) Text			
75			– Use copper wire only			
<b>Connecting instructions</b>						
Markings						
When intended for use as a motor disconnect the device shall be provided with a method of being locked in the OFF-position.						
<b>General Use</b>						
AC / DC	Voltage (V)	Current (A)	No. of phases	No. of poles	No. of contacts in series	
AC	600	30	1	2	1	
AC	600	30	3	3	1	
<b>CSA</b>						
<b>Nominal Voltage</b>						
			Voltage (V) AC / DC			
			600 AC			
<b>Rated insulation voltage Ui</b>						
			Voltage (V) AC / DC			
			600 AC			
<b>Rated thermal current</b>						
			Current (A)	Ambient temperature (°C) Additional Text		
			30	0 - 40 –		
<b>Horsepower rating</b>						
Across-the-Line Motor Starting		Voltage (V)	No. of phases	No. of poles	Power (HP)	Ambient temperature [°C]
DOL		110 - 120	1	2	1,50	40
DOL		220 - 240	1	2	3	40
DOL		277 - 277	1	2	3	40
DOL		415 - 415	1	2	5	40
DOL		440 - 480	1	2	5	40
DOL		550 - 600	1	2	5	40
DOL		110 - 120	3	3	3	40
DOL		220 - 240	3	3	7,50	40
DOL		415 - 415	3	3	10	40
DOL		440 - 480	3	3	10	40
DOL		550 - 600	3	3	10	40
<b>Pilot duty rating code</b>						
Duty Code						
A600						
<b>Temp. rating of wire</b>						
Temperature rating (°C)			Current (A) Text			
75			– only			
<b>General Use</b>						
AC / DC	Voltage (V)	Current (A)	No. of phases	No. of poles	No. of contacts in series	
AC	600	30	1	1	1	
<b>GENERAL TECHNICAL INFORMATION</b>						
<b>Size of conductor</b>						
composition of conductor	Min. / Max. value	No. of conductor per terminal	Cross section (mm <sup>2</sup> ) or (AWG/kcmil)		Material of the wire	
Solid wire	Min.		1	0.75mm <sup>2</sup>	Copper	
Solid wire	Min.		2	0.75mm <sup>2</sup>	Copper	
Flexible wire	Min.		1	1.5mm <sup>2</sup>	Copper	
Flexible wire	Max.		2	AWG 12	Copper	
Flexible wire	Max.		2	4mm <sup>2</sup>	Copper	
Flexible wire	Min.		2	1.5mm <sup>2</sup>	Copper	
Single-core or stranded wire	Max.		2	AWG 10	Copper	
Single-core or stranded wire	Max.		2	4mm <sup>2</sup>	Copper	
Flexible wire with ferrule according to DIN 46228	Min.		1	1mm <sup>2</sup>	Copper	
Flexible wire with ferrule according to DIN 46228	Max.		2	2.5mm <sup>2</sup>	Copper	
Flexible wire with ferrule according to DIN 46228	Min.		2	1mm <sup>2</sup>	Copper	
<b>Stripping length</b>						
			Length (mm) –			
						
<b>Recommended screw driver</b>						
Type of screw driver			Value			
Cross Screwdriver			PH1			
Slot screwdriver according to DIN 5264			0,8x5,5			
<b>Tightening torque of screws</b>						
			tightening torque (Nm)		tightening torque (lb-in)	
			1		9	
<b>Approbations</b>						
Specification						Marking
CE marking						

<b>Approbations</b>		<b>Marking</b>
<i>Specification</i>		<b>UK CA</b>
UK Directives		<b>SA</b>
CSA C.22.2 No.14		<b>SA</b>

<b>General Information</b>	
<i>Text</i>	
<p>- Alleen koperleidingen met of zonder vertinde/verzilverde draden (per draad) gebruiken. Het nadien vertinnen van de uiteinden is niet toegestaan.</p> <p>- Terminals with factory fitted jumper links are tightened during production for loss prevention. When opening the terminal clamps, make sure that no factory fitted links get lost and that all wire connections are properly seated.</p> <p>- After wiring, ALL terminal screws must be tightened to the specified torque values.</p> <p>- Het gebruik van een extra apparaat kan de beschermingsklasse van de gekozen bouwvorm beïnvloeden.</p> <p>- Do not lubricate or treat contacts.</p> <p>- Switches may only be mounted, connected and set into operation by qualified persons according to the accepted rules of technology.</p> <p>- After installation of the switches the spacings between the terminals must be sufficient to fulfill the requirement of the applicable standards.</p>	

<b>Waste Electrical &amp; Electronic Equipment (WEEE)</b>	
<i>Picture name</i>	<i>Description</i>
	Do not throw in the trash as care must be taken to ensure environmentally sound disposal and recycling. Please either use an environmentally friendly waste disposal company, return to the supplier for disposal, or return direct to the manufacturer, Kraus & Naimer. You can find local Kraus & Naimer offices at <a href="http://www.krausnaimer.com">www.krausnaimer.com</a>

<b>Proposition 65</b>	
<i>Picture name</i>	<i>Description</i>
	WARNING: This product can expose you to chemicals including nickel and lead, which is known to the State of California to cause cancer. For more information go to <a href="http://www.P65Warnings.ca.gov">www.P65Warnings.ca.gov</a> .

Classification Contact: Rigid contact bridge
Classification Contact Mat: Silver
Classification Terminal: Screw terminal

## Mounting-EF

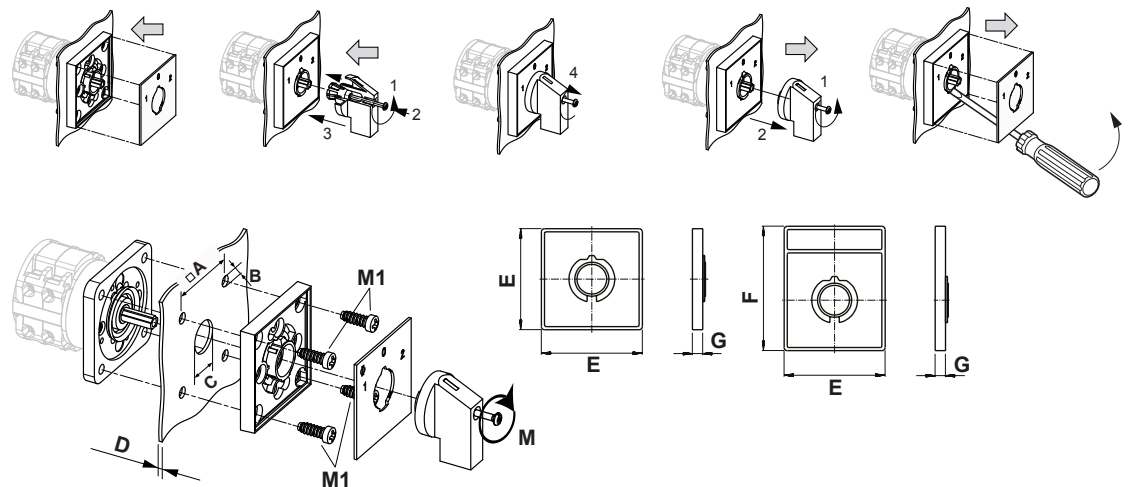

IP - Code front side	IP66, IP67, IP69k
Stages	1,00 - 12,00
A	□ 36,00 mm
B	∅ 5,00 mm
C	∅ 15,00 - 19,00 mm
D	H ≤ 4,00 mm
E	H 48,00 mm
F	H 59,00 mm
G	H 6,70 mm
M	↺ 0,50 Nm
M1	↺ 0,90 Nm

## Wiring diagram

CA20.A293.EF

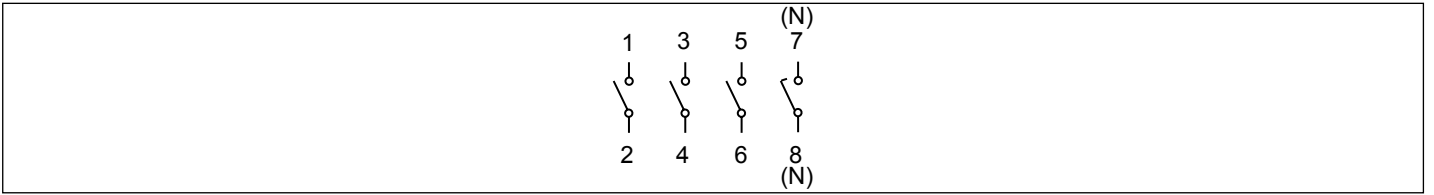

## Switch program

CA20.A293.EF

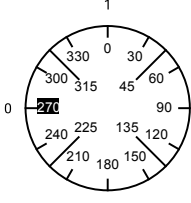
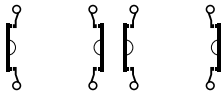
 Kraus & Naimer		CA20				A293				Page 1 of 1			
		1	3	5	7	9	11	13	15	17	19	21	23
<b>Face Plate</b> 													
Switching Angle <input type="text" value="90"/> Total switching Angle <input type="text" value="90"/>		2	4	6	8	10	12	14	16	18	20	22	24
0													
270													
285													
300													
315													
330													
345													
1													
0													
15													
30													
45													
60													
75													
90													
105													
120													
135													
150													
165													
180													
195													
210													
225													
240													
255													
		<b>Jumpers</b> 1 ●   ●3   4 ●   ●2 5 ●   ●7   8 ●   ●6 9 ○   ○11   12 ○   ○10 13 ○   ○15   16 ○   ○14 17 ○   ○19   20 ○   ○18 21 ○   ○23   24 ○   ○22 25 ○   ○27   28 ○   ○26 29 ○   ○31   32 ○   ○30 33 ○   ○35   36 ○   ○34 37 ○   ○39   40 ○   ○38 41 ○   ○43   44 ○   ○42 45 ○   ○47   48 ○   ○46											
		Version: 87											

**Face plate**

S0.F056/A1B.PEL

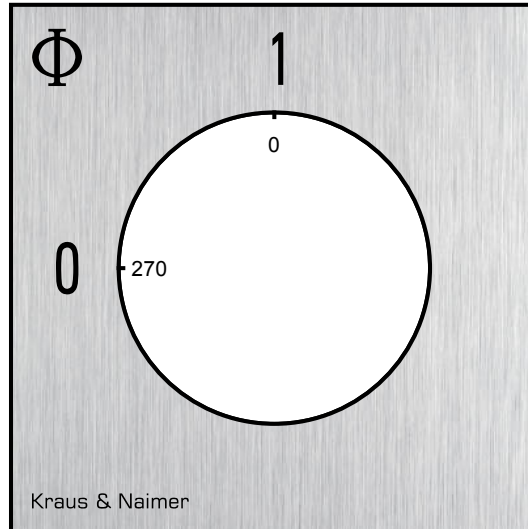

## HANDLES

**Designation:** SOC.G251  
**Handle colour:** "1" black

### GENERAL TECHNICAL INFORMATION

#### Recommended screw driver

Type of screw driver	Value
Cross Screwdriver	PH1
Slot screwdriver according to DIN 5264	0,8x4

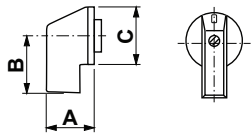

A	22,00 mm	B	23,80 mm	C	27,60 mm
---	----------	---	----------	---	----------