

Sample image





## Datasheet

**Article number:** 70010364

**Designation:** KG64B.T304.E

**Description:** Switch Local Disconnecter

| <b>IEC 60947-3 EN 60947-3, VDE 0660 Teil 107</b>   |                          |                       |  |              |                           |  |
|--|--------------------------|-----------------------|--|--------------|---------------------------|--|
| <b>Rated insulation voltage Ui</b>   |                          |                       |  |              |                           |  |
| Voltage (V) AC / DC  |                          |                       |  |              |                           |  |
| 690 AC   |                          |                       |  |              |                           |  |
| <b>Rated uninterrupted current Iu/Ith</b>  |                          |                       |  |              |                           |  |
| Current (A)  | Ambient temperature (°C) | Peak temperature (°C) | additional requirements  |              |                           |  |
| 63   | 50                       | 55                    | Ambient temperature +50°C during 24 hours with peaks up to +55°C |              |                           |  |
| <b>Rated operational current Ie</b>  |                          |                       |  |              |                           |  |
| Utilization category   |                          |                       |  |              |                           |  |
| AC-32A   |                          |                       |  |              |                           |  |
| Voltage (V)  |                          |                       |  |              |                           |  |
| 20 - 400   |                          |                       |  |              |                           |  |
| Current (A)  |                          |                       |  |              |                           |  |
| 63   |                          |                       |  |              |                           |  |
| <b>Rated operational power</b>   |                          |                       |  |              |                           |  |
| Utilization category   | Voltage (V)              | No. of phases         | No. of poles   | Power (kW)   |                           |  |
| AC-3   | 220 - 240                | 3                     | 3  | 11           |                           |  |
| AC-3   | 380 - 440                | 3                     | 3  | 18,50        |                           |  |
| AC-3   | 660 - 690                | 3                     | 3  | 15           |                           |  |
| AC-23A   | 220 - 240                | 3                     | 3  | 11           |                           |  |
| AC-23A   | 380 - 440                | 3                     | 3  | 22           |                           |  |
| AC-23A   | 660 - 690                | 3                     | 3  | 18,50        |                           |  |
| <b>Max. Fuse rating IEC</b>  |                          |                       |  |              |                           |  |
| Fuse characteristic  |                          |                       |  |              |                           |  |
| gG   |                          |                       |  |              |                           |  |
| No. of Fuses   |                          |                       |  |              |                           |  |
| 1  |                          |                       |  |              |                           |  |
| Current (A)  |                          |                       |  |              |                           |  |
| 63   |                          |                       |  |              |                           |  |
| <b>UL60947-4-1, UL508</b>  |                          |                       |  |              |                           |  |
| <b>Nominal Voltage</b>   |                          |                       |  |              |                           |  |
| Voltage (V) AC / DC  |                          |                       |  |              |                           |  |
| 600 AC   |                          |                       |  |              |                           |  |
| <b>Rated insulation voltage Ui</b>   |                          |                       |  |              |                           |  |
| Voltage (V) AC / DC  |                          |                       |  |              |                           |  |
| 600 AC   |                          |                       |  |              |                           |  |
| <b>Rated thermal current</b>   |                          |                       |  |              |                           |  |
| Current (A)  |                          |                       |  |              |                           |  |
| 60   |                          |                       |  |              |                           |  |
| Ambient temperature (°C) Additional Text   |                          |                       |  |              |                           |  |
| 0 - 40 -   |                          |                       |  |              |                           |  |
| <b>Horsepower rating</b>   |                          |                       |  |              |                           |  |
| Across-the-Line Motor Starting   | Voltage (V)              | No. of phases         | No. of poles   | Power (HP)   | Ambient temperature [°C]  |  |
| DOL  | 110 - 120                | 1                     | 2  | 3            | 40                        |  |
| DOL  | 220 - 240                | 1                     | 2  | 7,50         | 40                        |  |
| DOL  | 277 - 277                | 1                     | 2  | 7,50         | 40                        |  |
| DOL  | 415 - 415                | 1                     | 2  | 10           | 40                        |  |
| DOL  | 440 - 480                | 1                     | 2  | 15           | 40                        |  |
| DOL  | 550 - 600                | 1                     | 2  | 15           | 40                        |  |
| DOL  | 110 - 120                | 3                     | 3  | 5            | 40                        |  |
| DOL  | 220 - 240                | 3                     | 3  | 15           | 40                        |  |
| DOL  | 415 - 415                | 3                     | 3  | 20           | 40                        |  |
| DOL  | 440 - 480                | 3                     | 3  | 30           | 40                        |  |
| DOL  | 550 - 600                | 3                     | 3  | 40           | 40                        |  |
| <b>SCCR / Max. fuse rating</b>   |                          |                       |  |              |                           |  |
| <i>Conditions of acceptability</i>   |                          |                       |  |              |                           |  |
| This device is suitable for use on circuits capable of delivering not more than 10kA rms symmetrical amperes, 600V ac max. when protected by Type RK1 fuses.   |                          |                       |  |              |                           |  |
| Suitable for use on a circuit capable of delivering not more than 65000 rms symmetrical amperes 600V max., when protected by 70A Class J fuses.  |                          |                       |  |              |                           |  |
| <b>Temp. rating of wire</b>  |                          |                       |  |              |                           |  |
| Temperature rating (°C)  |                          |                       |  |              |                           |  |
| 60 - 75  |                          |                       |  |              |                           |  |
| Current (A) Text   |                          |                       |  |              |                           |  |
| -- --  |                          |                       |  |              |                           |  |
| <b>General Use</b>   |                          |                       |  |              |                           |  |
| AC / DC  | Voltage (V)              | Current (A)           | No. of phases  | No. of poles | No. of contacts in series |  |
| AC   | 277                      | 60                    | 1  | 1            | 1                         |  |
| AC   | 600                      | 60                    | 1  | 2            | 1                         |  |
| AC   | 600                      | 60                    | 3  | 3            | 1                         |  |
| <b>General Information</b>   |                          |                       |  |              |                           |  |
| <i>Text</i>  |                          |                       |  |              |                           |  |
| - The operating handle and position indicating means to be used with these manual motor controllers should be provided from the manufacturer, or the operating handle and position indicating means to be used should have been previously evaluated in combination with the manual motor controllers. |                          |                       |  |              |                           |  |

|  |  |                               |   |              |                           |   |
|--|--|-------------------------------|---|--------------|---------------------------|---|
| <b>General Information</b>   |  |                               |   |              |                           |   |
| <i>Text</i>  |  |                               |   |              |                           |   |
| - When intended for use as a motor disconnecter the device shall be provided with a method of being locked in the OFF-position.  |  |                               |   |              |                           |   |
| <b>CSA</b>   |  |                               |   |              |                           |   |
| <b>Nominal Voltage</b>   |  |                               |   |              |                           |   |
| Voltage (V) AC / DC<br>600 AC  |  |                               |   |              |                           |   |
| <b>Rated insulation voltage Ui</b>   |  |                               |   |              |                           |   |
| Voltage (V) AC / DC<br>600 AC  |  |                               |   |              |                           |   |
| <b>Rated thermal current</b>   |  |                               |   |              |                           |   |
| Current (A) Ambient temperature (°C) Additional Text<br>60 0 - 40 -  |  |                               |   |              |                           |   |
| <b>Horsepower rating</b>   |  |                               |   |              |                           |   |
| <i>Across-the-Line Motor Starting</i>  |  |                               |   |              |                           |   |
|  | Voltage (V)  | No. of phases                 | No. of poles                                    | Power (HP)   | Ambient temperature [°C]  |   |
| DOL  | 110 - 120  | 1                             | 2   | 3            | 40                        |   |
| DOL  | 220 - 240  | 1                             | 2   | 7,50         | 40                        |   |
| DOL  | 277 - 277  | 1                             | 2   | 7,50         | 40                        |   |
| DOL  | 415 - 415  | 1                             | 2   | 10           | 40                        |   |
| DOL  | 440 - 480  | 1                             | 2   | 15           | 40                        |   |
| DOL  | 110 - 120  | 3                             | 3   | 5            | 40                        |   |
| DOL  | 220 - 240  | 3                             | 3   | 15           | 40                        |   |
| DOL  | 415 - 415  | 3                             | 3   | 20           | 40                        |   |
| DOL  | 440 - 480  | 3                             | 3   | 30           | 40                        |   |
| DOL  | 550 - 600  | 3                             | 3   | 40           | 40                        |   |
| <b>Temp. rating of wire</b>  |  |                               |   |              |                           |   |
| Temperature rating (°C) Current (A) Text<br>75 -- --   |  |                               |   |              |                           |   |
| <b>General Use</b>   |  |                               |   |              |                           |   |
| AC / DC  | Voltage (V)  | Current (A)                   | No. of phases                                   | No. of poles | No. of contacts in series |   |
| AC   | 277  | 60                            | 1   | 1            | 1                         |   |
| AC   | 600  | 60                            | 1   | 2            | 1                         |   |
| AC   | 600  | 60                            | 3   | 3            | 1                         |   |
| <b>GENERAL TECHNICAL INFORMATION</b>   |  |                               |   |              |                           |   |
| <b>Size of conductor</b>   |  |                               |   |              |                           |   |
| composition of conductor   | Min. / Max. value  | No. of conductor per terminal | Cross section (mm <sup>2</sup> ) or (AWG/kcmil) |              | Material of the wire      |   |
| Flexible wire  | Max.   |                               | 1 AWG 6   |              | Copper                    |   |
| Flexible wire  | Max.   |                               | 1 10mm <sup>2</sup>                             |              | Copper                    |   |
| Single-core or stranded wire   | Max.   |                               | 1 AWG 6   |              | Copper                    |   |
| Single-core or stranded wire   | Max.   |                               | 1 16mm <sup>2</sup>                             |              | Copper                    |   |
| Flexible wire with sleeve  | Max.   |                               | 1 10mm <sup>2</sup>                             |              | Copper                    |   |
| <b>Stripping length</b>  |  |                               |   |              |                           |   |
| Length (mm) --   |  |                               |   |              |                           |   |
|   |  |                               |   |              |                           |   |
| <b>Recommended screw driver</b>  |  |                               |   |              |                           |   |
| Type of screw driver   | Value  |                               |   |              |                           |   |
| Cross Screwdriver  | PH2  |                               |   |              |                           |   |
| Slot screwdriver according to DIN 5264   | 1,2x6,5  |                               |   |              |                           |   |
| <b>Tightening torque of screws</b>   |  |                               |   |              |                           |   |
| tightening torque (Nm) tightening torque (lb-in)   |  |                               |   |              |                           |   |
| 1,80 16  |  |                               |   |              |                           |   |
| <b>Approbations</b>  |  |                               |   |              |                           |   |
| Specification  |  |                               |   |              |                           | Marking   |
| CE marking   |  |                               |   |              |                           |  |
| UK Directives  |  |                               |   |              |                           |  |
| CSA C.22.2 No.14   |  |                               |   |              |                           |  |
| <b>General Information</b>   |  |                               |   |              |                           |   |
| <i>Text</i>  |  |                               |   |              |                           |   |
| - Alleen koperleidingen met of zonder vertinde/verzilverde draden (per draad) gebruiken. Het nadien vertinnen van de uiteinden is niet toegestaan.   |  |                               |   |              |                           |   |
| - EMC Note: This device is suitable for use in environment A and B.  |  |                               |   |              |                           |   |
| - Terminals with factory fitted jumper links are tightened during production for loss prevention. When opening the terminal clamps, make sure that no factory fitted links get lost and that all wire connections are properly seated. |  |                               |   |              |                           |   |
| - After wiring, ALL terminal screws must be tightened to the specified torque values.  |  |                               |   |              |                           |   |
| - Het gebruik van een extra apparaat kan de beschermingsklasse van de gekozen bouwvorm beïnvloeden.  |  |                               |   |              |                           |   |
| - Do not lubricate or treat contacts.  |  |                               |   |              |                           |   |
| - Switches may only be mounted, connected and set into operation by qualified persons according to the accepted rules of technology.   |  |                               |   |              |                           |   |
| <b>Waste Electrical &amp; Electronic Equipment (WEEE)</b>  |  |                               |   |              |                           |   |
| Picture name   | Description  |                               |   |              |                           |   |
|    | Do not throw in the trash as care must be taken to ensure environmentally sound disposal and recycling. Please either use an environmentally friendly waste disposal company; return to the supplier for disposal; or return direct to the manufacturer, Kraus & Naimer. You can find local Kraus & Naimer offices at <a href="http://www.krausnaimer.com">www.krausnaimer.com</a> |                               |   |              |                           |   |

**Proposition 65**

Picture name Description

 WARNING: This product can expose you to chemicals including nickel and lead, which is known to the State of California to cause cancer. For more information go to [www.P65Warnings.ca.gov](http://www.P65Warnings.ca.gov).

Classification Contact: Rigid contact bridge

Classification Contact Mat: Silver

Classification Terminal: Screw terminal

**Mounting-E**

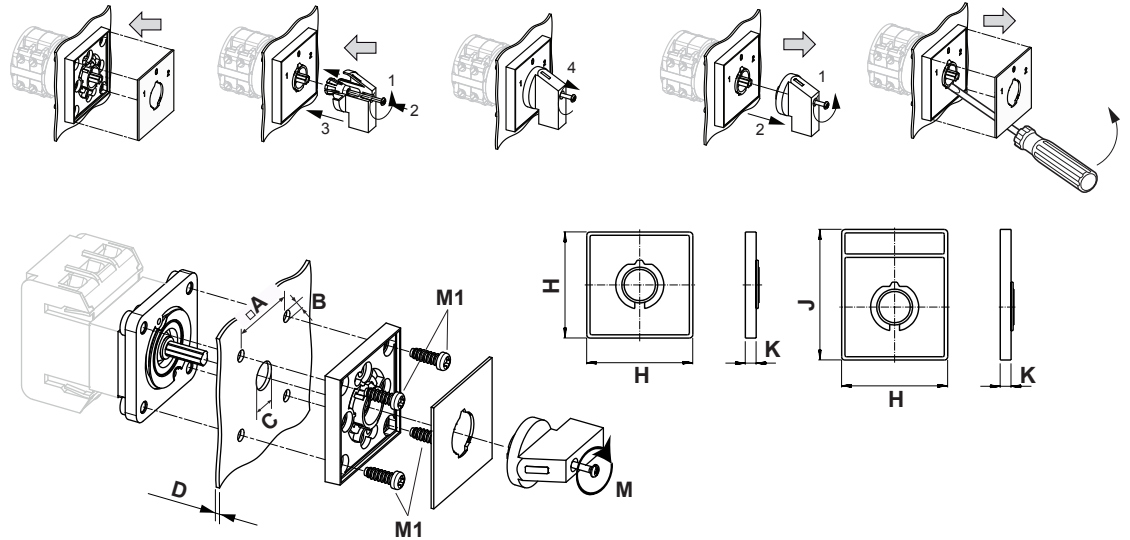

|                      |                    |
|----------------------|--------------------|
| IP - Code front side | IP66, IP67         |
| Stages               | 1,00 - 12,00       |
| A                    | □ 48,00 mm         |
| B                    | ∅ 5,00 mm          |
| C                    | ∅ 10,00 - 15,00 mm |
| D                    | H ≤ 4,00 mm        |
| H                    | H 64,00 mm         |
| J                    | H 78,00 mm         |
| K                    | H 7,40 mm          |
| M                    | ↺ 0,70 Nm          |
| M1                   | ↺ 0,90 Nm          |

## Wiring diagram

KG64B.T304.E

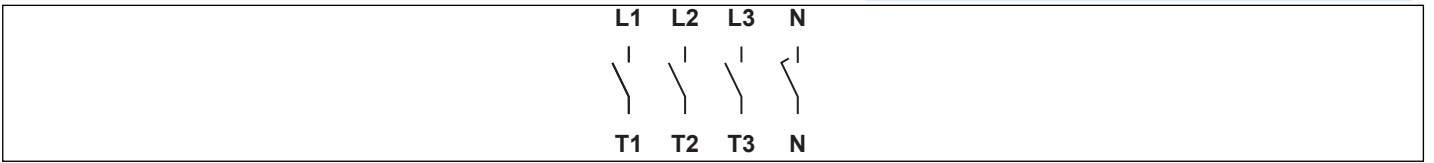



**Face plate**

S1.F456/A1B.PEL

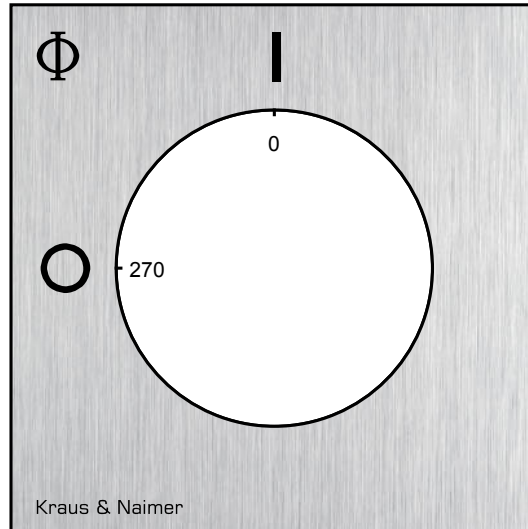

## HANDLES

**Designation:** S1B.G251  
**Handle colour:** "1" black

### GENERAL TECHNICAL INFORMATION

#### Recommended screw driver

| Type of screw driver                   | Value   |
|--|---------|
| Cross Screwdriver                      | PH1     |
| Slot screwdriver according to DIN 5264 | 0,8x5,5 |

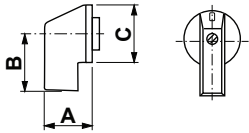

|   |          |   |          |   |          |
|---|----------|---|----------|---|----------|
| A | 27,00 mm | B | 31,80 mm | C | 36,00 mm |
|---|----------|---|----------|---|----------|