



Sample image





Datasheet

Article number: 70010858

Designation: KG20.T103/40.KL51V

Description: Switch Global Disconnecter

IEC 60947-3 EN 60947-3, VDE 0660 Teil 107						
Rated insulation voltage Ui						
			Voltage (V) AC / DC			
			690 AC			
Rated uninterrupted current Iu/Ith						
Current (A)	Ambient temperature (°C)	Peak temperature (°C)	additional requirements			
25	50	55	Ambient temperature +50°C during 24 hours with peaks up to +55°C			
Rated operational current Ie						
Utilization category			Voltage (V)		Current (A)	
AC-32A			20 - 400		20	
Rated operational power						
Utilization category	Voltage (V)	No. of phases	No. of poles	Power (kW)		
AC-3	220 - 240	3	3	4		
AC-3	380 - 440	3	3	5,50		
AC-3	660 - 690	3	3	5,50		
AC-23A	220 - 240	3	3	5,50		
AC-23A	380 - 440	3	3	7,50		
AC-23A	660 - 690	3	3	7,50		
Max. Fuse rating IEC						
Fuse characteristic			No. of Fuses		Current (A)	
gG			1		35	
UL60947-4-1, UL508						
Nominal Voltage						
			Voltage (V) AC / DC			
			600 AC			
Rated insulation voltage Ui						
			Voltage (V) AC / DC			
			600 AC			
Rated thermal current						
		Current (A)	Ambient temperature (°C)		Additional Text	
		25	0 - 40		-	
Horsepower rating						
Across-the-Line Motor Starting		Voltage (V)	No. of phases	No. of poles	Power (HP)	Ambient temperature [°C]
DOL		110 - 120	1	2	1	40
DOL		220 - 240	1	2	3	40
DOL		277 - 277	1	2	3	40
DOL		415 - 415	1	2	5	40
DOL		440 - 480	1	2	5	40
DOL		550 - 600	1	2	5	40
DOL		110 - 120	3	3	2	40
DOL		200 - 240	3	3	7,50	40
DOL		415 - 415	3	3	10	40
DOL		440 - 480	3	3	15	40
DOL		550 - 600	3	3	20	40
Pilot duty rating code						
Duty Code						
A600						
SCCR / Max. fuse rating						
Conditions of acceptability						
This device is suitable for use on circuits capable of delivering not more than 10kA rms symmetrical amperes, 600V ac max. when protected by Type RK1 fuses.						
Suitable for use on a circuit capable of delivering not more than 65000 rms symmetrical amperes at 600V max., when protected by 40A Class J fuses.						
Temp. rating of wire						
			Temperature rating (°C)		Current (A) Text	
			60 - 75		-- --	
General Use						
AC / DC	Voltage (V)	Current (A)	No. of phases	No. of poles	No. of contacts in series	
AC	277	25	1	1	1	
AC	600	25	1	2	1	
AC	600	25	3	3	1	
General Information						
Text						
- The operating handle and position indicating means to be used with these manual motor controllers should be provided from the manufacturer, or the operating handle and position indicating means to be used should have been previously evaluated in combination with the manual motor controllers.						

General Information						
<i>Text</i>						
- When intended for use as a motor disconnecter the device shall be provided with a method of being locked in the OFF-position.						
CSA						
Nominal Voltage						
Voltage (V) AC / DC 600 AC						
Rated insulation voltage Ui						
Voltage (V) AC / DC 600 AC						
Rated thermal current						
Current (A)		Ambient temperature (°C)			Additional Text	
25		0 - 40			-	
Horsepower rating						
Across-the-Line Motor Starting						
	Voltage (V)	No. of phases	No. of poles	Power (HP)	Ambient temperature [°C]	
DOL	110 - 120	1	2	1	40	
DOL	220 - 240	1	2	3	40	
DOL	277 - 277	1	2	3	40	
DOL	415 - 415	1	2	5	40	
DOL	440 - 480	1	2	5	40	
DOL	550 - 600	1	2	5	40	
DOL	110 - 120	3	3	2	40	
DOL	220 - 240	3	3	7,50	40	
DOL	415 - 415	3	3	10	40	
DOL	440 - 480	3	3	15	40	
DOL	550 - 600	3	3	20	40	
Pilot duty rating code						
<i>Duty Code</i>						
A600						
Temp. rating of wire						
Temperature rating (°C)			Current (A) Text			
75			-- --			
General Use						
AC / DC	Voltage (V)	Current (A)	No. of phases	No. of poles	No. of contacts in series	
AC	277	25	1	1	1	
AC	600	25	1	2	1	
AC	600	25	3	3	1	
GENERAL TECHNICAL INFORMATION						
Size of conductor						
<i>composition of conductor</i>	<i>Min. / Max. value</i>	<i>No. of conductor per terminal</i>	<i>Cross section (mm²) or (AWG/kcmil)</i>		<i>Material of the wire</i>	
Solid wire	Min.	1	0.75mm ²		Copper	
Solid wire	Min.	2	0.5mm ²		Copper	
Flexible wire	Min.	2	0.75mm ²		Copper	
Flexible wire	Max.	1	AWG 10		Copper	
Flexible wire	Max.	1	4mm ²		Copper	
Flexible wire	Min.	1	1.5mm ²		Copper	
Single-core or stranded wire	Max.	1	6mm ²		Copper	
Single-core or stranded wire	Max.	1	AWG 10		Copper	
Flexible wire with sleeve	Max.	1	4mm ²		Copper	
Flexible wire with ferrule according to DIN 46228	Min.	1	0.75mm ²		Copper	
Flexible wire with ferrule according to DIN 46228	Min.	2	0.5mm ²		Copper	
Stripping length						
Length (mm) --						
						
Recommended screw driver						
<i>Type of screw driver</i>				<i>Value</i>		
Cross Screwdriver				PH2		
Slot screwdriver according to DIN 5264				0,8x4		
Tightening torque of screws						
			<i>tightening torque (Nm)</i>		<i>tightening torque (lb-in)</i>	
			1,25		11	
Approbations						
<i>Specification</i>						<i>Marking</i>
CE marking						
UK Directives						
CSA C.22.2 No.14						
General Information						
<i>Text</i>						
- Alleen koperleidingen met of zonder vertinde/verzilverde draden (per draad) gebruiken. Het nadien vertinnen van de uiteinden is niet toegestaan.						
- EMC Note: This device is suitable for use in environment A and B.						

General Information

Text

- Terminals with factory fitted jumper links are tightened during production for loss prevention. When opening the terminal clamps, make sure that no factory fitted links get lost and that all wire connections are properly seated.
- After wiring, ALL terminal screws must be tightened to the specified torque values.
- Het gebruik van een extra apparaat kan de beschermingsklasse van de gekozen bouwvorm beïnvloeden.
- Do not lubricate or treat contacts.
- Switches may only be mounted, connected and set into operation by qualified persons according to the accepted rules of technology.

Waste Electrical & Electronic Equipment (WEEE)

Picture name Description



Do not throw in the trash as care must be taken to ensure environmentally sound disposal and recycling. Please either use an environmentally friendly waste disposal company; return to the supplier for disposal; or return direct to the manufacturer, Kraus & Naimer. You can find local Kraus & Naimer offices at www.krausnaimer.com

Proposition 65

Picture name Description



WARNING: This product can expose you to chemicals including nickel and lead, which is known to the State of California to cause cancer. For more information go to www.P65Warnings.ca.gov.

Classification Contact: Rigid contact bridge

Classification Contact Mat: Silver

Classification Terminal: Screw terminal

Mounting-KL51V

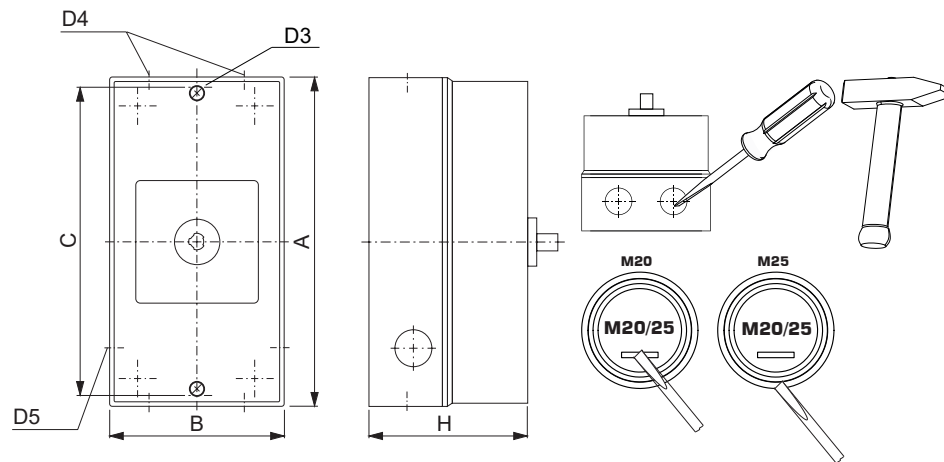

IP - Code front side	IP66, IP67, IP69k
Stages	1,00 - 5,00
A	H 160,00 mm
B	H 85,00 mm
C	H 150,00 mm
D3	Ø 4,20 mm
D4	Ø 4,00 x M20/M25
D5	Ø 2,00 x M20
H	H 82,00 mm

Wiring diagram

KG20.T303.KL51V

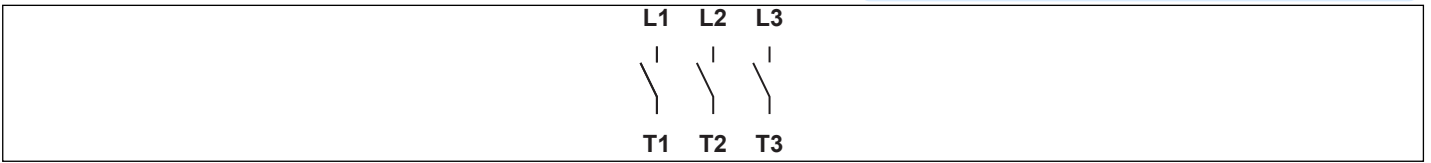

Switch program
KG20.T303.KL51V

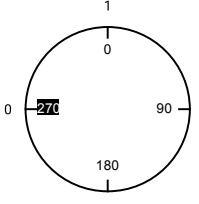
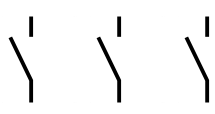
Face Plate		L1	L2	L3						
		1	3	5	7	9	11	13	15	
										
Switching Angle	90	2	4	6	8	10	12	14	16	
Total switching Angle	90	T1	T2	T3						
0	270									
1	0	■	■	■						
	90									
	180									

Version: 102

Face plate

S1.F656/C10.V9

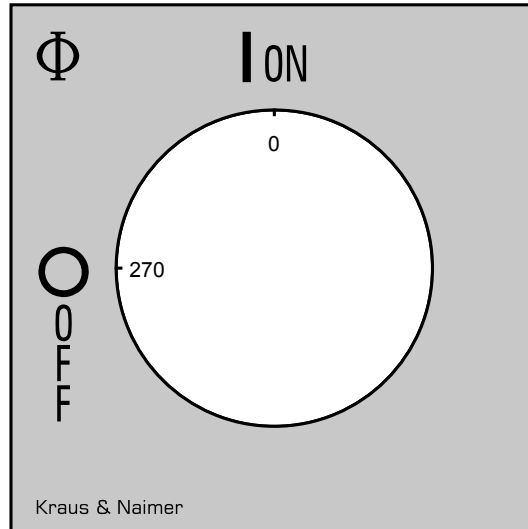

HANDLES

Designation: S1B.G841
Handle colour: "1" black

GENERAL TECHNICAL INFORMATION

Recommended screw driver

Type of screw driver	Value
Cross Screwdriver	PH1
Slot screwdriver according to DIN 5264	0,8x5,5

AUXILIARY CONTACTS

(cam operated) for switch type KG20 - KG100C and KH(R)16 - KH(R)25B

Designation: K0.M510A/2CA-B

Number of contacts: "2" 2 auxiliary contacts

Operation of contacts: "C" 1 auxiliary contact closed in pos. 1 and 1 auxiliary contact closed in pos. 0 (NO/NC)

Type of version: "A" 1. auxiliary contact module

Type of mounting: "-B" for type of mounting VE, VE2, silver contacts

IEC 60947-3 EN 60947-3, VDE 0660 Teil 107				
Nominal Voltage				
		Voltage (V) AC / DC		
		440 AC		
Rated uninterrupted current Iu/Ith				
Current (A)	Ambient temperature (°C)	Peak temperature (°C)	additional requirements	
10	55	60	Ambient temperature +55°C during 24 hours with peaks up to +60°C	
Rated operational current Ie				
Utilization category			Voltage (V)	Current (A)
AC-15			110 - 240	2,50
AC-15			380 - 440	1,50
AC-21A			440	10
UL60947-4-1, UL508				
Rated thermal current				
		Current (A)	Ambient temperature (°C)	Additional Text
		10	0 - 40	-
GENERAL TECHNICAL INFORMATION				
Size of conductor				
composition of conductor	Min. / Max. value	No. of conductor per terminal	Cross section (mm ²) or (AWG/kcmil)	Material of the wire
Solid wire	Min.	1	0.5mm ²	Copper
Solid wire	Min.	2	0.5mm ²	Copper
Flexible wire	Min.	1	0.75mm ²	Copper
Flexible wire	Min.	2	0.75mm ²	Copper
Flexible wire	Max.	2	AWG 16	Copper
Flexible wire	Max.	2	1.5mm ²	Copper
Single-core or stranded wire	Max.	2	AWG 14	Copper
Single-core or stranded wire	Max.	2	1.5mm ²	Copper
Flexible wire with ferrule according to DIN 46228	Min.	1	0.5mm ²	Copper
Flexible wire with ferrule according to DIN 46228	Max.	2	1mm ²	Copper
Flexible wire with ferrule according to DIN 46228	Min.	2	0.5mm ²	Copper
Stripping length				
		Length (mm) --		
				
Recommended screw driver				
Type of screw driver	Value			
Cross Screwdriver	PH1			
Slot screwdriver according to DIN 5264	0,6x3,5			
Tightening torque of screws				
		tightening torque (Nm)	tightening torque (lb-in)	
		0,40	3,50	
Conditions during transport and storing				
		Minimum temperature (°C)	Maximum temperature (°C)	additional requirements
		-40	85	In case of temperatures below -5°C no shock load permissible
General information				
Text				
<ul style="list-style-type: none"> - Alleen koperleidingen met of zonder vertinde/verzilverde draden (per draad) gebruiken. Het nadien vertinnen van de uiteinden is niet toegestaan. - Terminals with factory fitted jumper links are tightened during production for loss prevention. When opening the terminal clamps, make sure that no factory fitted links get lost and that all wire connections are properly seated. - After wiring, ALL terminal screws must be tightened to the specified torque values. - Do not lubricate or treat contacts. - Switches may only be mounted, connected and set into operation by qualified persons according to the accepted rules of technology. 				
Classification Terminal: Screw terminal				

13	21
	
14	22