

Sample image





Datasheet

Article number: 70011195

Designation: KG41B.T304.E

Description: Switch Local Disconnecter

IEC 60947-3 EN 60947-3, VDE 0660 Teil 107						
Rated insulation voltage Ui						
			Voltage (V) AC / DC			
			690 AC			
Rated uninterrupted current Iu/Ith						
Current (A)	Ambient temperature (°C)	Peak temperature (°C)	additional requirements			
40	50	55	Ambient temperature +50°C during 24 hours with peaks up to +55°C			
Rated operational current Ie						
Utilization category			Voltage (V)		Current (A)	
AC-32A			20 - 400		40	
Rated operational power						
Utilization category	Voltage (V)	No. of phases	No. of poles	Power (kW)		
AC-3	220 - 240	3	3	7,50		
AC-3	380 - 440	3	3	11		
AC-3	660 - 690	3	3	11		
AC-23A	220 - 240	3	3	7,50		
AC-23A	380 - 440	3	3	15		
AC-23A	660 - 690	3	3	15		
Max. Fuse rating IEC						
Fuse characteristic			No. of Fuses		Current (A)	
gG			1		50	
UL60947-4-1, UL508						
Nominal Voltage						
			Voltage (V) AC / DC			
			600 AC			
Rated insulation voltage Ui						
			Voltage (V) AC / DC			
			600 AC			
Rated thermal current						
		Current (A)	Ambient temperature (°C)		Additional Text	
		42	0 - 40		-	
Horsepower rating						
Across-the-Line Motor Starting		Voltage (V)	No. of phases	No. of poles	Power (HP)	Ambient temperature [°C]
DOL		110 - 120	1	2	2	40
DOL		220 - 240	1	2	5	40
DOL		277 - 277	1	2	7,50	40
DOL		415 - 415	1	2	7,50	40
DOL		440 - 480	1	2	10	40
DOL		550 - 600	1	2	10	40
DOL		110 - 120	3	3	5	40
DOL		220 - 240	3	3	15	40
DOL		415 - 415	3	3	15	40
DOL		440 - 480	3	3	25	40
DOL		550 - 600	3	3	30	40
Pilot duty rating code						
Duty Code						
A600						
SCCR / Max. fuse rating						
Conditions of acceptability						
This device is suitable for use on circuits capable of delivering not more than 10kA rms symmetrical amperes, 600V ac max. when protected by Type RK1 fuses.						
Suitable for use on a circuit capable of delivering not more than 65000 rms symmetrical amperes 600V max., when protected by 60A Class J fuses.						
Temp. rating of wire						
			Temperature rating (°C)	Current (A) Text		
			60 - 75	-- --		
General Use						
AC / DC	Voltage (V)	Current (A)	No. of phases	No. of poles	No. of contacts in series	
AC	277	42	1	1	1	
AC	600	42	1	2	1	
AC	600	42	3	3	1	
General Information						
Text						
- The operating handle and position indicating means to be used with these manual motor controllers should be provided from the manufacturer, or the operating handle and position indicating means to be used should have been previously evaluated in combination with the manual motor controllers.						

General Information						
<i>Text</i>						
- When intended for use as a motor disconnecter the device shall be provided with a method of being locked in the OFF-position.						
CSA						
Nominal Voltage						
Voltage (V) AC / DC 600 AC						
Rated insulation voltage Ui						
Voltage (V) AC / DC 600 AC						
Rated thermal current						
Current (A)		Ambient temperature (°C)		Additional Text		
40		0 - 40		-		
Horsepower rating						
Across-the-Line Motor Starting						
	Voltage (V)	No. of phases	No. of poles	Power (HP)	Ambient temperature [°C]	
DOL	110 - 120	1	2	2	40	
DOL	220 - 240	1	2	5	40	
DOL	277 - 277	1	2	7,50	40	
DOL	415 - 415	1	2	7,50	40	
DOL	440 - 480	1	2	10	40	
DOL	550 - 600	1	2	10	40	
DOL	110 - 120	3	3	5	40	
DOL	220 - 240	3	3	15	40	
DOL	415 - 415	3	3	15	40	
DOL	440 - 480	3	3	25	40	
DOL	550 - 600	3	3	30	40	
Temp. rating of wire						
Temperature rating (°C)			Current (A) Text			
75			-- --			
General Use						
AC / DC	Voltage (V)	Current (A)	No. of phases	No. of poles	No. of contacts in series	
AC	277	40	1	1	1	
AC	600	40	1	2	1	
AC	600	40	3	3	1	
GENERAL TECHNICAL INFORMATION						
Size of conductor						
composition of conductor	Min. / Max. value	No. of conductor per terminal	Cross section (mm ²) or (AWG/kcmil)		Material of the wire	
Flexible wire	Max.	1	AWG 6		Copper	
Flexible wire	Max.	1	10mm ²		Copper	
Single-core or stranded wire	Max.	1	AWG 6		Copper	
Single-core or stranded wire	Max.	1	16mm ²		Copper	
Flexible wire with sleeve	Max.	1	10mm ²		Copper	
Stripping length						
Length (mm) --						
						
Recommended screw driver						
Type of screw driver	Value					
Cross Screwdriver	PH2					
Slot screwdriver according to DIN 5264	1,2x6,5					
Tightening torque of screws						
tightening torque (Nm)			tightening torque (lb-in)			
1,80			16			
Approbations						
Specification						Marking
CE marking						
UK Directives						
CSA C.22.2 No.14						
General Information						
<i>Text</i>						
- Alleen koperleidingen met of zonder vertinde/verzilverde draden (per draad) gebruiken. Het nadien vertinnen van de uiteinden is niet toegestaan.						
- EMC Note: This device is suitable for use in environment A and B.						
- Terminals with factory fitted jumper links are tightened during production. When opening the terminal clamps, make sure that no factory fitted links get lost and that all wire connections are properly seated.						
- After wiring, ALL terminal screws must be tightened to the specified torque values.						
- Het gebruik van een extra apparaat kan de beschermingsklasse van de gekozen bouwvorm beïnvloeden.						
- Do not lubricate or treat contacts.						
- Switches may only be mounted, connected and set into operation by qualified persons according to the accepted rules of technology.						
Waste Electrical & Electronic Equipment (WEEE)						
Picture name	Description					
	Do not throw in the trash as care must be taken to ensure environmentally sound disposal and recycling. Please either use an environmentally friendly waste disposal company, return to the supplier for disposal, or return direct to the manufacturer, Kraus & Naimer. You can find local Kraus & Naimer offices at www.krausnaimer.com					

Proposition 65

Picture name Description

 WARNING: This product can expose you to chemicals including nickel and lead, which is known to the State of California to cause cancer. For more information go to www.P65Warnings.ca.gov.

Classification Contact: Rigid contact bridge

Classification Contact Mat: Silver

Classification Terminal: Screw terminal

Mounting-E

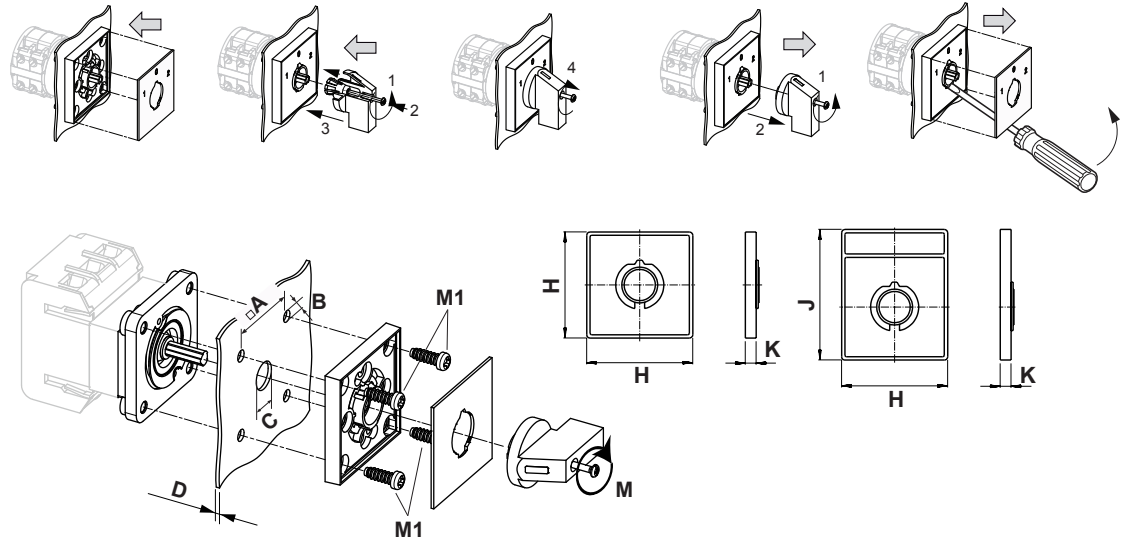

IP - Code front side	IP66, IP67
Stages	1,00 - 12,00
A	□ 48,00 mm
B	∅ 5,00 mm
C	∅ 10,00 - 15,00 mm
D	H ≤ 4,00 mm
H	H 64,00 mm
J	H 78,00 mm
K	H 7,40 mm
M	↺ 0,70 Nm
M1	↺ 0,90 Nm

Wiring diagram

KG41B.T304.E

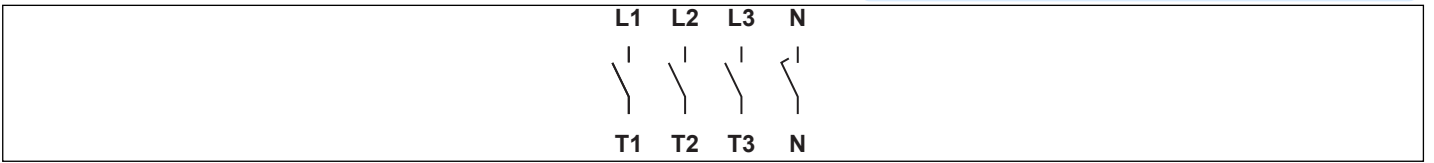

Switch program

KG41B.T304.E

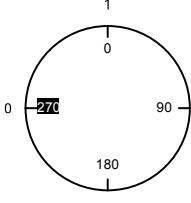
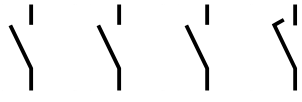
 Kraus & Naimer		KG41B				T304				Page 1 of 1			
		Face Plate											
		L1 1	L2 3	L3 5	N 7	9	11	13	15				
													
Switching Angle <input type="text" value="90"/> Total switching Angle <input type="text" value="90"/>		2	4	6	8	10	12	14	16				
		T1	T2	T3	N								
0		270											
1		0	■	■	■	■							
		90											
		180											
Version: 95													

Face plate

S1.F456/A1B.PEL

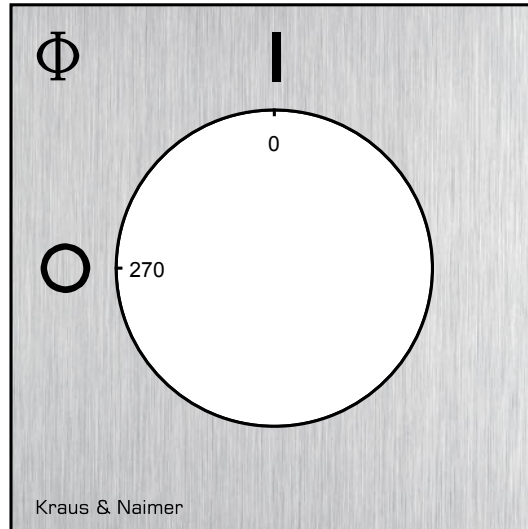

HANDLES

Designation: S1B.G251
Handle colour: "1" black

GENERAL TECHNICAL INFORMATION

Recommended screw driver

Type of screw driver	Value
Cross Screwdriver	PH1
Slot screwdriver according to DIN 5264	0,8x5,5

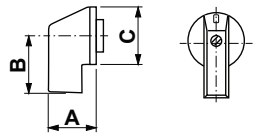

A	27,00 mm	B	31,80 mm	C	36,00 mm
---	----------	---	----------	---	----------