







Sample image

Datasheet

Article number: 70012298
Designation: CG4.A290.E-V
Description: Switch

IEC 60947-3 EN 60947-3, VDE 0660 Teil 107						
Rated insulation voltage Ui						
			Voltage (V) AC / DC			
			440 AC / DC			
Rated uninterrupted current Iu/Ith						
Current (A)	Ambient temperature (°C)		Peak temperature (°C)		additional requirements	
10	55		60		Ambient temperature +55°C during 24 hours with peaks up to +60°C	
Rated operational current Ie						
Utilization category			Voltage (V)		Current (A)	
AC-15			220 - 240		2,50	
AC-15			380 - 440		1,50	
Rated operational power						
Utilization category	Voltage (V)		No. of phases		No. of poles	
AC-3	220 - 240		3		3	
AC-3	380 - 440		3		3	
AC-3	220 - 240		1		2	
AC-3	380 - 440		1		2	
AC-23A	220 - 240		3		3	
AC-23A	380 - 440		3		3	
AC-23A	220 - 240		1		2	
AC-23A	380 - 440		1		2	
Max. Fuse rating IEC						
Fuse characteristic			No. of Fuses		Current (A)	
gG			1		10	
UL60947-4-1, UL508						
Nominal Voltage						
			Voltage (V) AC / DC			
			300 AC			
Rated insulation voltage Ui						
			Voltage (V) AC / DC			
			300 AC			
Rated thermal current						
		Current (A)		Ambient temperature (°C)		Additional Text
		10		0 - 40		-
Horsepower rating						
<i>Across-the-Line Motor Starting</i>			Voltage (V)		No. of phases	
DOL			110 - 120		1	
DOL			220 - 240		1	
DOL			277 - 277		1	
DOL			110 - 120		3	
DOL			220 - 240		3	
					No. of poles	
					2	
					2	
					3	
					3	
					1	
					Power (HP)	
					0,33	
					0,75	
					0,75	
					0,75	
					1	
					Ambient temperature [°C]	
					40	
					40	
					40	
					40	
					40	
Pilot duty rating code						
Duty Code						
A300						
Temp. rating of wire						
			Temperature rating (°C)		Current (A) Text	
			60 - 75		- Use copper wire only	
General Use						
AC / DC	Voltage (V)		Current (A)		No. of phases	
AC	120		10		1	
AC	300		10		1	
AC	300		10		3	
					No. of poles	
					1	
					2	
					3	
					No. of contacts in series	
					1	
					1	
					1	
CSA						
Nominal Voltage						
			Voltage (V) AC / DC			
			300 AC			
Rated insulation voltage Ui						
			Voltage (V) AC / DC			
			300 AC			

Rated thermal current						
		Current (A)			Ambient temperature (°C)	Additional Text
		10			0 - 40	--
Horsepower rating						
Across-the-Line Motor Starting						
	Voltage (V)	No. of phases	No. of poles	Power (HP)	Ambient temperature [°C]	
DOL	110 - 120	1	2	0,33	40	
DOL	220 - 240	1	2	0,75	40	
DOL	277 - 277	1	2	0,75	40	
DOL	110 - 120	3	3	0,75	40	
DOL	220 - 240	3	3	1	40	
Pilot duty rating code						
Duty Code						
A300						
Temp. rating of wire						
		Temperature rating (°C)			Current (A)	Text
		75			--	--
General Use						
AC / DC	Voltage (V)	Current (A)	No. of phases	No. of poles	No. of contacts in series	
AC	120	10	1	1	1	
AC	300	10	1	2	1	
AC	300	10	3	3	1	
GENERAL TECHNICAL INFORMATION						
Size of conductor						
composition of conductor	Min. / Max. value	No. of conductor per terminal	Cross section (mm ²) or (AWG/kcmil)		Material of the wire	
Solid wire	Min.	1	0.5mm ²		Copper	
Solid wire	Min.	2	0.5mm ²		Copper	
Flexible wire	Min.	1	0.75mm ²		Copper	
Flexible wire	Min.	2	0.75mm ²		Copper	
Flexible wire	Max.	2	AWG 16		Copper	
Flexible wire	Max.	2	1.5mm ²		Copper	
Single-core or stranded wire	Max.	2	AWG 14		Copper	
Single-core or stranded wire	Max.	2	1.5mm ²		Copper	
Flexible wire with ferrule according to DIN 46228	Min.	1	0.5mm ²		Copper	
Flexible wire with ferrule according to DIN 46228	Max.	2	1mm ²		Copper	
Flexible wire with ferrule according to DIN 46228	Min.	2	0.5mm ²		Copper	
Stripping length						
Length (mm) --						
						
Recommended screw driver						
Type of screw driver		Value				
Cross Screwdriver		PH1				
Slot screwdriver according to DIN 5264		0,6x3,5				
Tightening torque of screws						
		tightening torque (Nm)			tightening torque (lb-in)	
		0,40			3,50	
Approbations						
Specification					Marking	
CE marking						
UK Directives						
CSA C.22.2 No.14						
General Information						
Text						
<ul style="list-style-type: none"> - Alleen koperleidingen met of zonder vertinde/verzilverde draden (per draad) gebruiken. Het nadien vertinnen van de uiteinden is niet toegestaan. - Terminals with factory fitted jumper links are tightened during production for loss prevention. When opening the terminal clamps, make sure that no factory fitted links get lost and that all wire connections are properly seated. - After wiring, ALL terminal screws must be tightened to the specified torque values. - Het gebruik van een extra apparaat kan de beschermingsklasse van de gekozen bouwvorm beïnvloeden. - Do not lubricate or treat contacts. - Switches may only be mounted, connected and set into operation by qualified persons according to the accepted rules of technology. - After installation of the switches the spacings between the terminals must be sufficient to fulfill the requirement of the applicable standards. 						
Waste Electrical & Electronic Equipment (WEEE)						
Picture name	Description					
	Do not throw in the trash as care must be taken to ensure environmentally sound disposal and recycling. Please either use an environmentally friendly waste disposal company; return to the supplier for disposal; or return direct to the manufacturer, Kraus & Naimer. You can find local Kraus & Naimer offices at www.krausnaimer.com					
Proposition 65						
Picture name	Description					
	WARNING: This product can expose you to chemicals including nickel and lead, which is known to the State of California to cause cancer. For more information go to www.P65Warnings.ca.gov .					
Classification Contact: Rigid contact bridge						
Classification Contact Mat: Silver						
Classification Terminal: Screw terminal						

Mounting-E-V

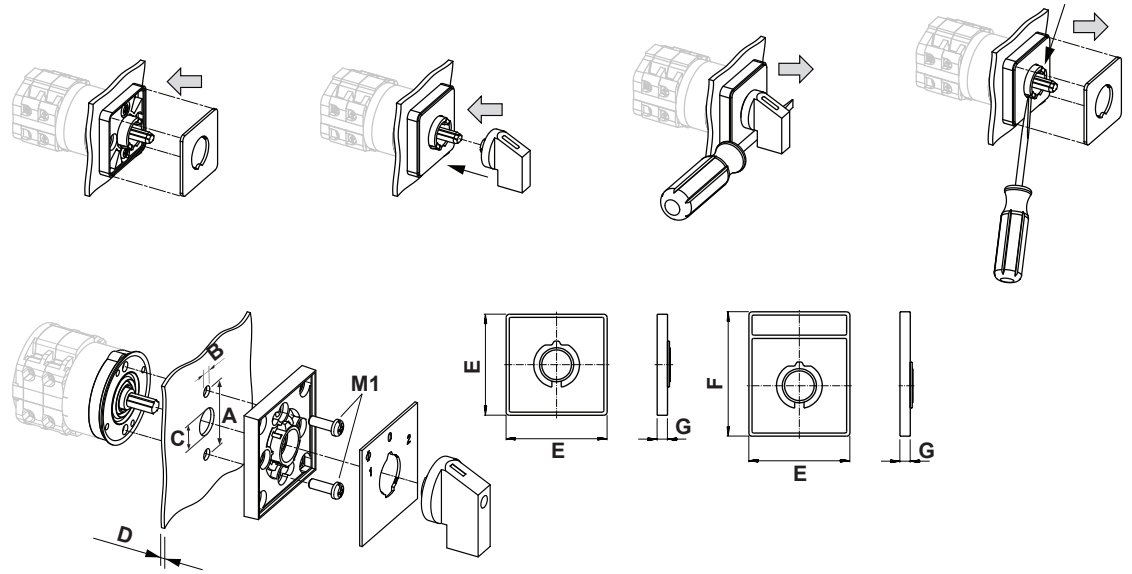

IP - Code front side	IP40
Stages	1,00 - 8,00
A	H 20,00 mm
B	Ø 3,20 mm
C	Ø 8,00 - 11,00 mm
D	H ≤ 4,00 mm
E	H 30,00 mm
F	H 39,00 mm
G	H 5,50 mm
M1	↺ 0,40 Nm

Wiring diagram

CG4.A290.E-V

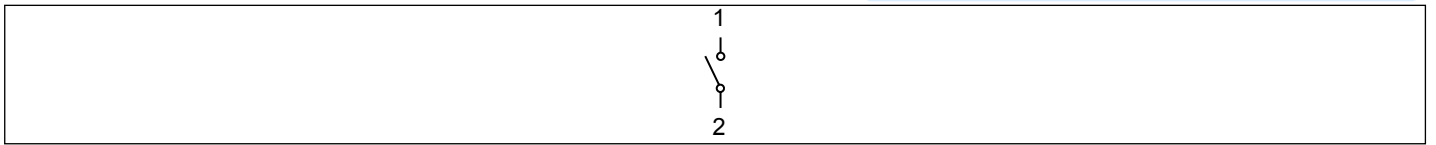

Switch program

CG4.A290.E-V

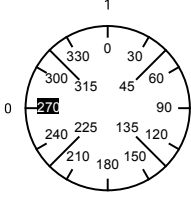
 Kraus & Naimer		CG4	A290	E	Page 1 of 1								
Face Plate													
		1	3	5	7	9	11	13	15	17	19	21	23
Switching Angle <input type="text" value="90"/> Total switching Angle <input type="text" value="90"/>		2	4	6	8	10	12	14	16	18	20	22	24
0	270												
	285												
	300												
	315												
	330												
	345												
1	0												
	15												
	30												
	45												
	60												
	75												
	90												
	105												
	120												
	135												
	150												
	165												
	180												
	195												
	210												
	225												
	240												
	255												
		Jumpers											
		1 ●	○3	4 ○	●2								
		5 ○	○7	8 ○	○6								
		9 ○	○11	12 ○	○10								
		13 ○	○15	16 ○	○14								
		17 ○	○19	20 ○	○18								
		21 ○	○23	24 ○	○22								
		25 ○	○27	28 ○	○26								
		29 ○	○31	32 ○	○30								
		33 ○	○35	36 ○	○34								
		37 ○	○39	40 ○	○38								
		41 ○	○43	44 ○	○42								
		45 ○	○47	48 ○	○46								
Version: 81													

Face plate

S00.F056/A1B.PE

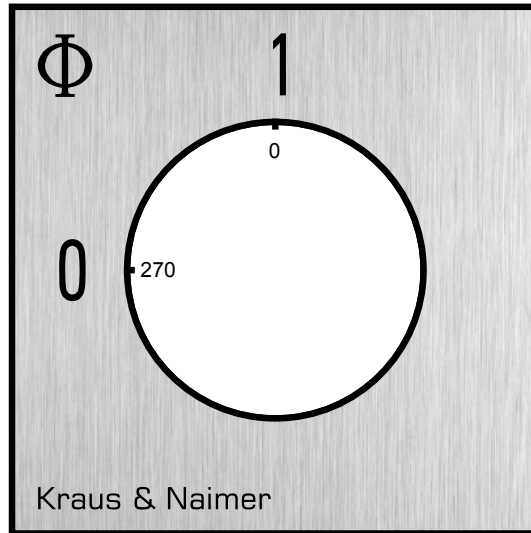

HANDLES

Designation: S00.G251
Handle colour: "1" black

