



Sample image

Datasheet

Article number: 70012802

Designation: KG20B.T106/40.KL11V

Description: Switch Global Disconnecter

IEC 60947-3 EN 60947-3, VDE 0660 Teil 107						
Rated insulation voltage Ui						
			Voltage (V) AC / DC			
			690 AC			
Rated uninterrupted current Iu/Ith						
Current (A)	Ambient temperature (°C)	Peak temperature (°C)	additional requirements			
25	50	55	Ambient temperature +50°C during 24 hours with peaks up to +55°C			
Rated operational current Ie						
Utilization category			Voltage (V)		Current (A)	
AC-32A			20 - 400		20	
Rated operational power						
Utilization category	Voltage (V)	No. of phases	No. of poles	Power (kW)		
AC-3	220 - 240	3	3	4		
AC-3	380 - 440	3	3	5,50		
AC-3	660 - 690	3	3	5,50		
AC-23A	220 - 240	3	3	5,50		
AC-23A	380 - 440	3	3	7,50		
AC-23A	660 - 690	3	3	7,50		
Max. Fuse rating IEC						
Fuse characteristic			No. of Fuses		Current (A)	
gG			1		35	
UL60947-4-1, UL508						
Nominal Voltage						
			Voltage (V) AC / DC			
			600 AC			
Rated insulation voltage Ui						
			Voltage (V) AC / DC			
			600 AC			
Rated thermal current						
		Current (A)	Ambient temperature (°C)		Additional Text	
		25	0 - 40		-	
Horsepower rating						
<i>Across-the-Line Motor Starting</i>		Voltage (V)	No. of phases	No. of poles	Power (HP)	Ambient temperature [°C]
DOL		110 - 120	1	2	1	40
DOL		220 - 240	1	2	3	40
DOL		277 - 277	1	2	3	40
DOL		415 - 415	1	2	5	40
DOL		440 - 480	1	2	5	40
DOL		550 - 600	1	2	5	40
DOL		110 - 120	3	3	2	40
DOL		200 - 240	3	3	7,50	40
DOL		415 - 415	3	3	10	40
DOL		440 - 480	3	3	15	40
DOL		550 - 600	3	3	20	40
Pilot duty rating code						
Duty Code						
A600						
SCCR / Max. fuse rating						
<i>Conditions of acceptability</i>						
This device is suitable for use on circuits capable of delivering not more than 10kA rms symmetrical amperes, 600V ac max. when protected by Type RK1 fuses.						
Suitable for use on a circuit capable of delivering not more than 65000 rms symmetrical amperes at 600V max., when protected by 40A Class J fuses.						
Temp. rating of wire						
			Temperature rating (°C)	Current (A) Text		
			60 - 75	-- --		
General Use						
AC / DC	Voltage (V)	Current (A)	No. of phases	No. of poles	No. of contacts in series	
AC	277	25	1	1	1	

General Use					
AC / DC	Voltage (V)	Current (A)	No. of phases	No. of poles	No. of contacts in series
AC	600	25	1	2	1
AC	600	25	3	3	1

General Information

Text

- The operating handle and position indicating means to be used with these manual motor controllers should be provided from the manufacturer, or the operating handle and position indicating means to be used should have been previously evaluated in combination with the manual motor controllers.

- When intended for use as a motor disconnecter the device shall be provided with a method of being locked in the OFF-position.

CSA

Nominal Voltage	
Voltage (V)	AC / DC
600	AC

Rated insulation voltage Ui	
Voltage (V)	AC / DC
600	AC

Rated thermal current		
Current (A)	Ambient temperature (°C)	Additional Text
25	0 - 40	-

Horsepower rating					
Across-the-Line Motor Starting	Voltage (V)	No. of phases	No. of poles	Power (HP)	Ambient temperature [°C]
DOL	110 - 120	1	2	1	40
DOL	220 - 240	1	2	3	40
DOL	277 - 277	1	2	3	40
DOL	415 - 415	1	2	5	40
DOL	440 - 480	1	2	5	40
DOL	550 - 600	1	2	5	40
DOL	110 - 120	3	3	2	40
DOL	220 - 240	3	3	7,50	40
DOL	415 - 415	3	3	10	40
DOL	440 - 480	3	3	15	40
DOL	550 - 600	3	3	20	40

Pilot duty rating code	
Duty Code	Temp. rating of wire
A600	Temperature rating (°C)
	Current (A) Text
	75 -- --

General Use					
AC / DC	Voltage (V)	Current (A)	No. of phases	No. of poles	No. of contacts in series
AC	277	25	1	1	1
AC	600	25	1	2	1
AC	600	25	3	3	1

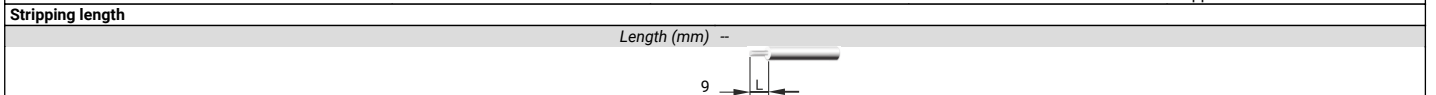

GENERAL TECHNICAL INFORMATION

Size of conductor				
composition of conductor	Min. / Max. value	No. of conductor per terminal	Cross section (mm ²) or (AWG/kcmil)	Material of the wire
Flexible wire	Max.	1	AWG 10	Copper
Flexible wire	Max.	1	4mm ²	Copper
Single-core or stranded wire	Max.	1	6mm ²	Copper
Single-core or stranded wire	Max.	1	AWG 10	Copper
Flexible wire with sleeve	Max.	1	4mm ²	Copper



Recommended screw driver	
Type of screw driver	Value
Cross Screwdriver	PH2
Slot screwdriver according to DIN 5264	0,8x4

Tightening torque of screws		
	tightening torque (Nm)	tightening torque (lb-in)
	1,25	11

Approbations	
Specification	Marking
CE marking	
UK Directives	
CSA C.22.2 No.14	

General Information

Text

- Alleen koperleidingen met of zonder vertinde/verzilverde draden (per draad) gebruiken. Het nadien vertinnen van de uiteinden is niet toegestaan.

- EMC Note: This device is suitable for use in environment A and B.

General Information

Text

- Terminals with factory fitted jumper links are tightened during production for loss prevention. When opening the terminal clamps, make sure that no factory fitted links get lost and that all wire connections are properly seated.
- After wiring, ALL terminal screws must be tightened to the specified torque values.
- Het gebruik van een extra apparaat kan de beschermingsklasse van de gekozen bouwvorm beïnvloeden.
- Do not lubricate or treat contacts.
- Switches may only be mounted, connected and set into operation by qualified persons according to the accepted rules of technology.

Waste Electrical & Electronic Equipment (WEEE)

Picture name Description

-  Do not throw in the trash as care must be taken to ensure environmentally sound disposal and recycling. Please either use an environmentally friendly waste disposal company; return to the supplier for disposal; or return direct to the manufacturer, Kraus & Naimer. You can find local Kraus & Naimer offices at www.krausnaimer.com

Proposition 65

Picture name Description

-  WARNING: This product can expose you to chemicals including nickel and lead, which is known to the State of California to cause cancer. For more information go to www.P65Warnings.ca.gov.

Classification Contact: Rigid contact bridge

Classification Contact Mat: Silver

Classification Terminal: Screw terminal

Mounting-KL11V

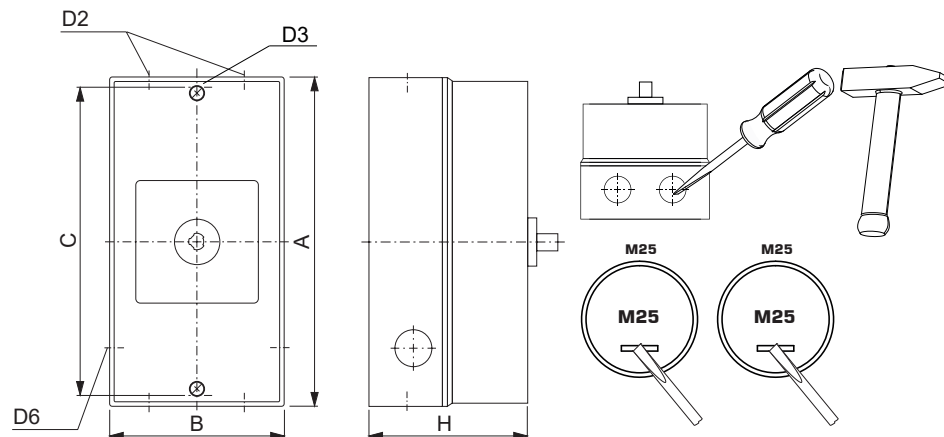

IP - Code front side	IP66, IP67, IP69k
Stages	6,00 - 6,00
A	H 190,00 mm
B	H 100,00 mm
C	H 178,00 mm
D2	Ø 4,00 x M25
D3	Ø 5,60 mm
D6	Ø 2,00 x M25
H	H 93,00 mm

Wiring diagram

KG20B.T306.KL11V

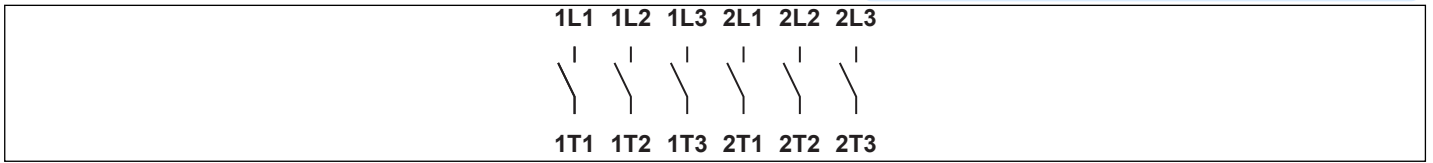

Switch program
KG20B.T306.KL11V

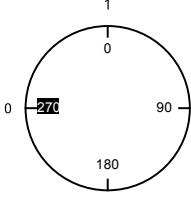
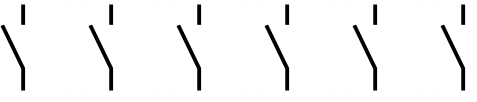

KG20B	T306	Page 1 of 1
--------------	-------------	--------------------

Face Plate			1L1	1L2	1L3	2L1	2L2	2L3	13	15
			1	3	5	7	9	11		15
										
Switching Angle <input type="text" value="90"/> Total switching Angle <input type="text" value="90"/>			2	4	6	8	10	12	14	16
			1T1	1T2	1T3	2T1	2T2	2T3		
0	270									
1	0									
	90									
	180									
		Version: 117								

Face plate

S1.F656/C10.V9

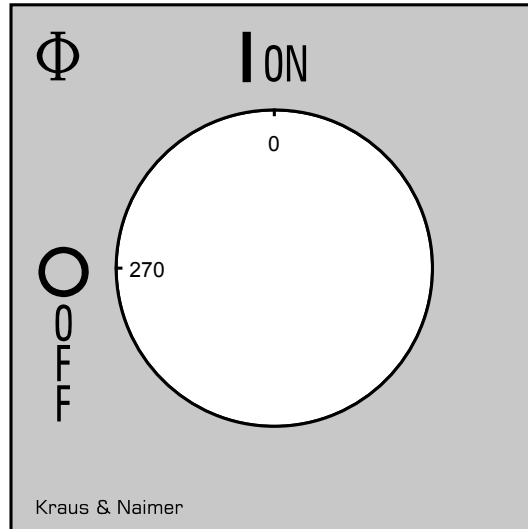

HANDLES

Designation: S1B.G841
Handle colour: "1" black

GENERAL TECHNICAL INFORMATION

Recommended screw driver

Type of screw driver	Value
Cross Screwdriver	PH1
Slot screwdriver according to DIN 5264	0,8x5,5

AUXILIARY CONTACTS

(cam operated) for switch type KG20 - KG100C and KH(R)16 - KH(R)25B

Designation: K0.M510A/2CA-B

Number of contacts: "2" 2 auxiliary contacts

Operation of contacts: "C" 1 auxiliary contact closed in pos. 1 and 1 auxiliary contact closed in pos. 0 (NO/NC)

Type of version: "A" 1. auxiliary contact module

Type of mounting: "-B" for type of mounting VE, VE2, silver contacts

IEC 60947-3 EN 60947-3, VDE 0660 Teil 107				
Nominal Voltage				
		Voltage (V) AC / DC		
		440 AC		
Rated uninterrupted current Iu/Ith				
Current (A)	Ambient temperature (°C)	Peak temperature (°C)	additional requirements	
10	55	60	Ambient temperature +55°C during 24 hours with peaks up to +60°C	
Rated operational current Ie				
Utilization category			Voltage (V)	Current (A)
AC-15			110 - 240	2,50
AC-15			380 - 440	1,50
AC-21A			440	10
UL60947-4-1, UL508				
Rated thermal current				
		Current (A)	Ambient temperature (°C)	Additional Text
		10	0 - 40	-
GENERAL TECHNICAL INFORMATION				
Size of conductor				
composition of conductor	Min. / Max. value	No. of conductor per terminal	Cross section (mm ²) or (AWG/kcmil)	Material of the wire
Solid wire	Min.	1	0.5mm ²	Copper
Solid wire	Min.	2	0.5mm ²	Copper
Flexible wire	Min.	1	0.75mm ²	Copper
Flexible wire	Min.	2	0.75mm ²	Copper
Flexible wire	Max.	2	AWG 16	Copper
Flexible wire	Max.	2	1.5mm ²	Copper
Single-core or stranded wire	Max.	2	AWG 14	Copper
Single-core or stranded wire	Max.	2	1.5mm ²	Copper
Flexible wire with ferrule according to DIN 46228	Min.	1	0.5mm ²	Copper
Flexible wire with ferrule according to DIN 46228	Max.	2	1mm ²	Copper
Flexible wire with ferrule according to DIN 46228	Min.	2	0.5mm ²	Copper
Stripping length				
		Length (mm) --		
				
Recommended screw driver				
Type of screw driver	Value			
Cross Screwdriver	PH1			
Slot screwdriver according to DIN 5264	0,6x3,5			
Tightening torque of screws				
		tightening torque (Nm)	tightening torque (lb-in)	
		0,40	3,50	
Conditions during transport and storing				
		Minimum temperature (°C)	Maximum temperature (°C)	additional requirements
		-40	85	In case of temperatures below -5°C no shock load permissible
General information				
Text				
<ul style="list-style-type: none"> - Alleen koperleidingen met of zonder vertinde/verzilverde draden (per draad) gebruiken. Het nadien vertinnen van de uiteinden is niet toegestaan. - Terminals with factory fitted jumper links are tightened during production for loss prevention. When opening the terminal clamps, make sure that no factory fitted links get lost and that all wire connections are properly seated. - After wiring, ALL terminal screws must be tightened to the specified torque values. - Do not lubricate or treat contacts. - Switches may only be mounted, connected and set into operation by qualified persons according to the accepted rules of technology. 				
Classification Terminal: Screw terminal				

13	21
14	22