



Sample image

## Datasheet

**Article number:** 70014771  
**Designation:** CH10.A232.EF  
**Description:** Switch

<b>IEC 60947-3 EN 60947-3, VDE 0660 Teil 107</b>						
<b>Rated insulation voltage Ui</b>						
			Voltage (V) AC / DC			
			690 AC / DC			
<b>Rated uninterrupted current Iu/Ith</b>						
Current (A)	Ambient temperature (°C)		Peak temperature (°C)		additional requirements	
20	55		60		Ambient temperature +55°C during 24 hours with peaks up to +60°C	
<b>Rated operational current Ie</b>						
Utilization category			Voltage (V)		Current (A)	
AC-15			220 - 240		6	
AC-15			380 - 440		4	
<b>Rated operational power</b>						
Utilization category	Voltage (V)		No. of phases		No. of poles	
AC-3	220 - 240		3		3	
AC-3	380 - 440		3		3	
AC-3	660 - 690		3		3	
AC-3	220 - 240		1		2	
AC-3	380 - 440		1		2	
AC-23A	220 - 240		3		3	
AC-23A	380 - 440		3		3	
AC-23A	660 - 690		3		3	
AC-23A	220 - 240		1		2	
AC-23A	380 - 440		1		2	
<b>Max. Fuse rating IEC</b>						
Fuse characteristic			No. of Fuses		Current (A)	
gG			1		25	
<b>UL60947-4-1 , UL508</b>						
<b>Nominal Voltage</b>						
			Voltage (V) AC / DC			
			600 AC			
<b>Rated insulation voltage Ui</b>						
			Voltage (V) AC / DC			
			600 AC			
<b>Rated thermal current</b>						
		Current (A)	Ambient temperature (°C)		Additional Text	
		20	0 - 40		-	
<b>Horsepower rating</b>						
Across-the-Line Motor Starting			Voltage (V)	No. of phases	No. of poles	Power (HP)
DOL			110 - 120	1	2	0,50
DOL			220 - 240	1	2	1
DOL			277 - 277	1	2	2
DOL			440 - 480	1	2	2
DOL			550 - 600	1	2	2
DOL			110 - 120	3	3	1,50
DOL			220 - 240	3	3	3
DOL			440 - 480	3	3	5
DOL			550 - 600	3	3	5
<b>Pilot duty rating code</b>						
Duty Code						
A600						
<b>SCCR / Max. fuse rating</b>						
Conditions of acceptability						
These devices are suitable for use on circuits capable of delivering not more than 5kA rms symmetrical amperes, 600V ac max. when protected by Class RK1 fuses.						
<b>Temp. rating of wire</b>						
			Temperature rating (°C)	Current (A)		Text
			60 - 75			- Use copper wire only
<b>General Use</b>						
AC / DC	Voltage (V)	Current (A)	No. of phases	No. of poles		No. of contacts in series
AC	277	20	1	1		1
AC	600	20	1	2		1

General Use					
AC / DC	Voltage (V)	Current (A)	No. of phases	No. of poles	No. of contacts in series
AC	600	20	3	3	1
CSA					
Nominal Voltage					
			Voltage (V) AC / DC		
			600 AC		
Rated insulation voltage Ui					
			Voltage (V) AC / DC		
			600 AC		
Rated thermal current					
		Current (A)	Ambient temperature (°C)		Additional Text
		20	0 - 40		--
Horsepower rating					
Across-the-Line Motor Starting	Voltage (V)	No. of phases	No. of poles	Power (HP)	Ambient temperature [°C]
DOL	110 - 120	1	2	0,50	40
DOL	220 - 240	1	2	1	40
DOL	277 - 277	1	2	2	40
DOL	440 - 480	1	2	2	40
DOL	550 - 600	1	2	2	40
DOL	110 - 120	3	3	1,50	40
DOL	220 - 240	3	3	3	40
DOL	440 - 480	3	3	5	40
DOL	550 - 600	3	3	5	40
Pilot duty rating code					
Duty Code					
A600					
Temp. rating of wire					
			Temperature rating (°C)	Current (A) Text	
			75	-- --	
General Use					
AC / DC	Voltage (V)	Current (A)	No. of phases	No. of poles	No. of contacts in series
AC	277	20	1	1	1
AC	600	20	1	2	1
AC	600	20	3	3	1
GENERAL TECHNICAL INFORMATION					
Size of conductor					
composition of conductor	Min. / Max. value	No. of conductor per terminal	Cross section (mm <sup>2</sup> ) or (AWG/kcmil)		Material of the wire
Solid wire	Min.	1	0.75mm <sup>2</sup>		Copper
Solid wire	Min.	2	0.75mm <sup>2</sup>		Copper
Flexible wire	Min.	1	0.75mm <sup>2</sup>		Copper
Flexible wire	Min.	2	0.75mm <sup>2</sup>		Copper
Flexible wire	Max.	2	AWG 12		Copper
Flexible wire	Max.	2	2.5mm <sup>2</sup>		Copper
Single-core or stranded wire	Max.	2	AWG 10		Copper
Single-core or stranded wire	Max.	2	4mm <sup>2</sup>		Copper
Flexible wire with ferrule according to DIN 46228	Min.	1	0.75mm <sup>2</sup>		Copper
Flexible wire with ferrule according to DIN 46228	Min.	2	0.75mm <sup>2</sup>		Copper
Flexible wire with ferrule according to DIN 46228	Max.	2	2.5mm <sup>2</sup>		Copper
Stripping length					
Length (mm) --					
					
Recommended screw driver					
Type of screw driver			Value		
Cross Screwdriver			PH1		
Slot screwdriver according to DIN 5264			0,8x4		
Tightening torque of screws					
			tightening torque (Nm)	tightening torque (lb-in)	
			1	9	
Approbations					
Specification					Marking
CE marking					
UK Directives					
CSA C.22.2 No.14					
General Information					
Text					
- Alleen koperleidingen met of zonder vertinde/verzilverde draden (per draad) gebruiken. Het nadien vertinnen van de uiteinden is niet toegestaan.					
- Terminals with factory fitted jumper links are tightened during production for loss prevention. When opening the terminal clamps, make sure that no factory fitted links get lost and that all wire connections are properly seated.					
- After wiring, ALL terminal screws must be tightened to the specified torque values.					
- Het gebruik van een extra apparaat kan de beschermingsklasse van de gekozen bouwvorm beïnvloeden.					

### General Information

**Text**

- Do not lubricate or treat contacts.
- Switches may only be mounted, connected and set into operation by qualified persons according to the accepted rules of technology.
- After installation of the switches the spacings between the terminals must be sufficient to fulfill the requirement of the applicable standards.

### Waste Electrical & Electronic Equipment (WEEE)

Picture name Description

 Do not throw in the trash as care must be taken to ensure environmentally sound disposal and recycling. Please either use an environmentally friendly waste disposal company; return to the supplier for disposal; or return direct to the manufacturer, Kraus & Naimer. You can find local Kraus & Naimer offices at [www.krausnaimer.com](http://www.krausnaimer.com)

### Proposition 65

Picture name Description

 WARNING: This product can expose you to chemicals including nickel and lead, which is known to the State of California to cause cancer. For more information go to [www.P65Warnings.ca.gov](http://www.P65Warnings.ca.gov).

Classification Contact: Rigid contact bridge

Classification Contact Mat: Silver

Classification Terminal: Screw terminal

### Mounting-EF

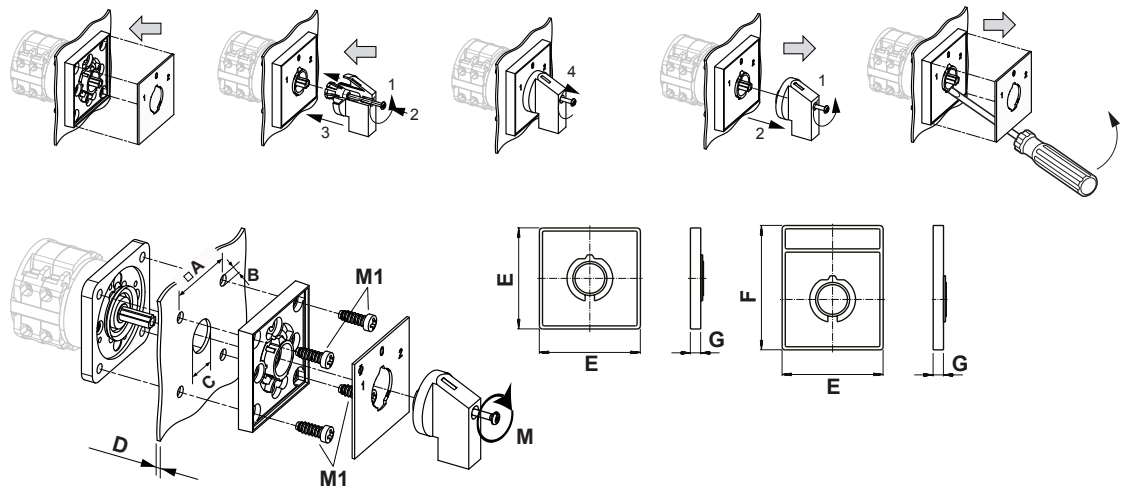

IP - Code front side	IP66, IP67, IP69k
Stages	1,00 - 12,00
A	□ 36,00 mm
B	∅ 5,00 mm
C	∅ 15,00 - 19,00 mm
D	H ≤ 4,00 mm
E	H 48,00 mm
F	H 59,00 mm
G	H 6,70 mm
M	↺ 0,50 Nm
M1	↺ 0,90 Nm

## Wiring diagram

CH10.A232.EF

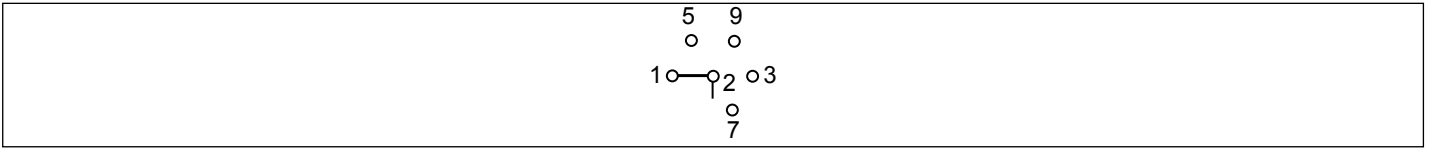

# Switch program

CH10.A232.EF



CH10    A232    E    Page 1 of 1

**Face Plate**

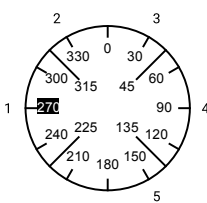
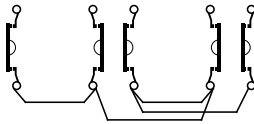
Switching Angle

Total switching Angle

	2	4	6	8	10	12	14	16	18	20	22	24
1	270	■										
	285											
	300											
	315											
2	330		■									
	345											
	0											
	15											
3	30				■							
	45											
	60											
	75											
4	90	■										
	105											
	120											
	135											
5	150			■								
	165											
	180											
	195											
	210											
	225											
	240											
	255											

**Jumpers**

1 ●	● 3	4 ○ — 2
5 ●	● 7	8 ○ — 6
9 ●	○ 11	12 ○ — 10
13 ○	○ 15	16 ○ — 14
17 ○	○ 19	20 ○ — 18
21 ○	○ 23	24 ○ — 22
25 ○	○ 27	28 ○ — 26
29 ○	○ 31	32 ○ — 30
33 ○	○ 35	36 ○ — 34
37 ○	○ 39	40 ○ — 38
41 ○	○ 43	44 ○ — 42
45 ○	○ 47	48 ○ — 46

Version: 77

**Face plate**

S0.F078/A1B.PEL

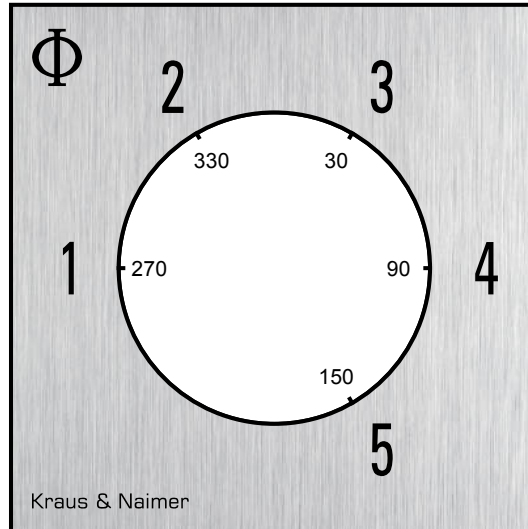

## HANDLES

**Designation:** SOC.G251  
**Handle colour:** "1" black

### GENERAL TECHNICAL INFORMATION

#### Recommended screw driver

Type of screw driver	Value
Cross Screwdriver	PH1
Slot screwdriver according to DIN 5264	0,8x4

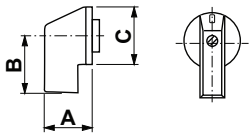

A	22,00 mm	B	23,80 mm	C	27,60 mm
---	----------	---	----------	---	----------