



Sample image

Datasheet

Article number: 70026000

Designation: KG32.T203/33.KL51V

Description: Switch Global Disconnecter

IEC 60947-3 EN 60947-3, VDE 0660 Teil 107						
Rated insulation voltage Ui						
		Voltage (V) AC / DC				
		690 AC				
Rated uninterrupted current Iu/Ith						
Current (A)	Ambient temperature (°C)	Peak temperature (°C)	additional requirements			
32	50	55	Ambient temperature +50°C during 24 hours with peaks up to +55°C			
Rated operational current Ie						
Utilization category		Voltage (V)		Current (A)		
AC-32A		20 - 400		32		
Rated operational power						
Utilization category	Voltage (V)	No. of phases	No. of poles	Power (kW)		
AC-3	220 - 240	3	3	5,50		
AC-3	380 - 440	3	3	7,50		
AC-3	660 - 690	3	3	7,50		
AC-23A	220 - 240	3	3	5,50		
AC-23A	380 - 440	3	3	11		
AC-23A	660 - 690	3	3	11		
Max. Fuse rating IEC						
Fuse characteristic		No. of Fuses		Current (A)		
gG		1		35		
UL60947-4-1 , UL508						
Nominal Voltage						
		Voltage (V) AC / DC				
		600 AC				
Rated insulation voltage Ui						
		Voltage (V) AC / DC				
		600 AC				
Rated thermal current						
		Current (A)	Ambient temperature (°C)	Additional Text		
		30	0 - 40	-		
Horsepower rating						
Across-the-Line Motor Starting	Voltage (V)	No. of phases	No. of poles	Power (HP)	Ambient temperature [°C]	
DOL	110 - 120	1	2	1,50	40	
DOL	200 - 208	1	2	3	40	
DOL	220 - 240	1	2	5	40	
DOL	277 - 277	1	2	5	40	
DOL	415 - 415	1	2	5	40	
DOL	440 - 480	1	2	7,50	40	
DOL	550 - 600	1	2	7,50	40	
DOL	110 - 120	3	3	3	40	
DOL	200 - 240	3	3	10	40	
DOL	415 - 415	3	3	10	40	
DOL	440 - 480	3	3	20	40	
DOL	550 - 600	3	3	25	40	
Pilot duty rating code						
Duty Code						
A600						
SCCR / Max. fuse rating						
Conditions of acceptability						
This device is suitable for use on circuits capable of delivering not more than 10kA rms symmetrical amperes, 600V ac max. when protected by Type RK1 fuses.						
Suitable for use on a circuit capable of delivering not more than 65000 rms symmetrical amperes at 600V max., when protected by 40A Class J fuses.						
Temp. rating of wire						
		Temperature rating (°C)	Current (A) Text			
		60 - 75	--			
General Use						
AC / DC	Voltage (V)	Current (A)	No. of phases	No. of poles	No. of contacts in series	
AC	277	30	1	1	1	

General Use					
AC / DC	Voltage (V)	Current (A)	No. of phases	No. of poles	No. of contacts in series
AC	600	30	1	2	1
AC	600	30	3	3	1

General Information
Text

- The operating handle and position indicating means to be used with these manual motor controllers should be provided from the manufacturer, or the operating handle and position indicating means to be used should have been previously evaluated in combination with the manual motor controllers.
- When intended for use as a motor disconnecter the device shall be provided with a method of being locked in the OFF-position.

CSA
Nominal Voltage

Voltage (V) AC / DC
600 AC

Rated insulation voltage Ui

Voltage (V) AC / DC
600 AC

Rated thermal current

Current (A) Ambient temperature (°C) Additional Text
30 0 - 40 --

Horsepower rating

Across-the-Line Motor Starting	Voltage (V)	No. of phases	No. of poles	Power (HP)	Ambient temperature [°C]
DOL	110 - 120	1	2	1,50	40
DOL	220 - 240	1	2	5	40
DOL	277 - 277	1	2	5	40
DOL	415 - 415	1	2	5	40
DOL	440 - 480	1	2	7,50	40
DOL	550 - 600	1	2	7,50	40
DOL	110 - 120	3	3	3	40
DOL	220 - 240	3	3	10	40
DOL	415 - 415	3	3	10	40
DOL	440 - 480	3	3	20	40
DOL	550 - 600	3	3	25	40

Pilot duty rating code
Duty Code

A600

Temp. rating of wire

Temperature rating (°C) Current (A) Text
75 -- --

General Use

AC / DC	Voltage (V)	Current (A)	No. of phases	No. of poles	No. of contacts in series
AC	277	30	1	1	1
AC	600	30	1	2	1
AC	600	30	3	3	1

GENERAL TECHNICAL INFORMATION
Size of conductor

composition of conductor	Min. / Max. value	No. of conductor per terminal	Cross section (mm ²) or (AWG/kcmil)	Material of the wire
Solid wire	Min.	1	0.75mm ²	Copper
Solid wire	Min.	2	0.5mm ²	Copper
Flexible wire	Min.	2	0.75mm ²	Copper
Flexible wire	Max.	1	AWG 10	Copper
Flexible wire	Max.	1	4mm ²	Copper
Flexible wire	Min.	1	1.5mm ²	Copper
Single-core or stranded wire	Max.	1	6mm ²	Copper
Single-core or stranded wire	Max.	1	AWG 10	Copper
Flexible wire with sleeve	Max.	1	4mm ²	Copper
Flexible wire with ferrule according to DIN 46228	Min.	1	0.75mm ²	Copper
Flexible wire with ferrule according to DIN 46228	Min.	2	0.5mm ²	Copper

Stripping length

Length (mm) --





Recommended screw driver

Type of screw driver	Value
Cross Screwdriver	PH2
Slot screwdriver according to DIN 5264	0,8x4

Tightening torque of screws

tightening torque (Nm) tightening torque (lb-in)
1,25 11

Approbations

Specification	Marking
CE marking	
UK Directives	
CSA C.22.2 No.14	

Approbations

Specification	Marking
GB/T14048.3	 <small>GB/T14048.3</small>

General Information

Text

- Alleen koperleidingen met of zonder vertinde/verzilverde draden (per draad) gebruiken. Het nadien vertinnen van de uiteinden is niet toegestaan.
- EMC Note: This device is suitable for use in environment A and B.
- Terminals with factory fitted jumper links are tightened during production for loss prevention. When opening the terminal clamps, make sure that no factory fitted links get lost and that all wire connections are properly seated.
- After wiring, ALL terminal screws must be tightened to the specified torque values.
- Het gebruik van een extra apparaat kan de beschermingsklasse van de gekozen bouwvorm beïnvloeden.
- Do not lubricate or treat contacts.
- Switches may only be mounted, connected and set into operation by qualified persons according to the accepted rules of technology.

Waste Electrical & Electronic Equipment (WEEE)

Picture name Description

 Do not throw in the trash as care must be taken to ensure environmentally sound disposal and recycling. Please either use an environmentally friendly waste disposal company; return to the supplier for disposal; or return direct to the manufacturer, Kraus & Naimer. You can find local Kraus & Naimer offices at www.krausnaimer.com

Proposition 65

Picture name Description

 **WARNING:** This product can expose you to chemicals including nickel and lead, which is known to the State of California to cause cancer. For more information go to www.P65Warnings.ca.gov.

Classification Contact: Rigid contact bridge
 Classification Contact Mat: Silver
 Classification Terminal: Screw terminal

Mounting-KL51V

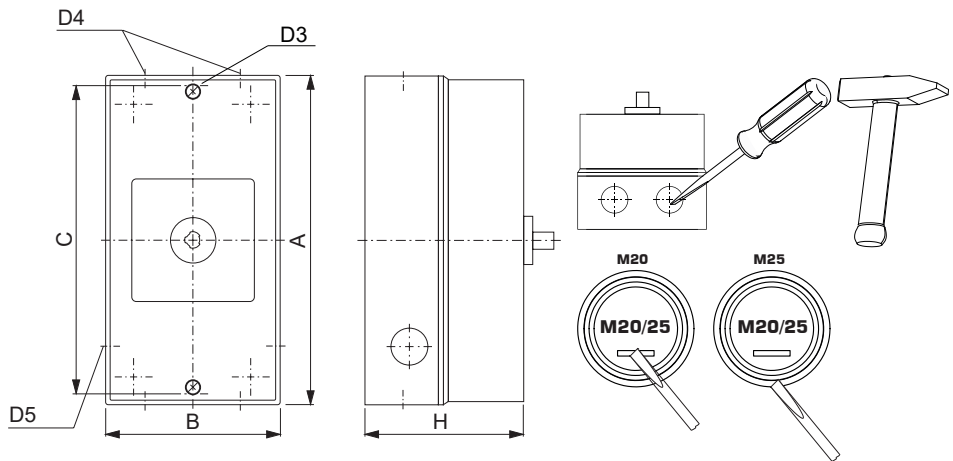

IP - Code front side	IP66, IP67, IP69k
Stages	1,00 - 5,00
A	H 160,00 mm
B	H 85,00 mm
C	H 150,00 mm
D3	∅ 4,20 mm
D4	∅ 4,00 x M20/M25
D5	∅ 2,00 x M20
H	H 82,00 mm

Wiring diagram

KG32.T303.KL51V

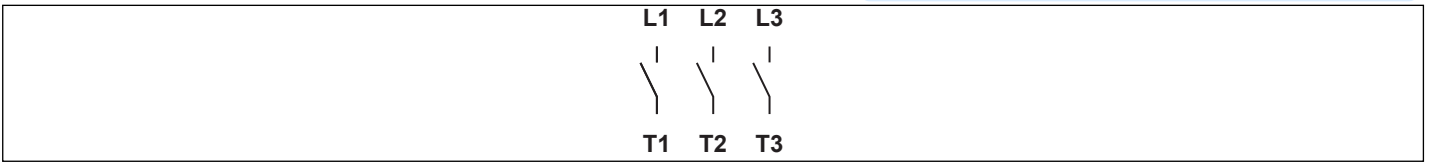

Face plate

S1.F656/E10.V9

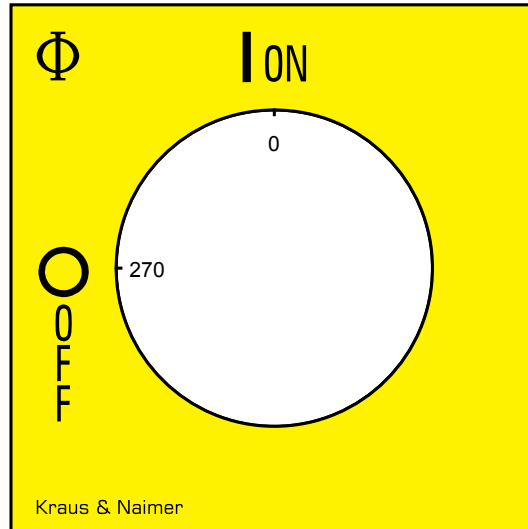

HANDLES

Designation: S1B.G842

Handle colour: "2" red

GENERAL TECHNICAL INFORMATION

Recommended screw driver

Type of screw driver	Value
Cross Screwdriver	PH1
Slot screwdriver according to DIN 5264	0,8x5,5